



OptiMair™ Vertical Laminar Flow Cabinet,
Model ACB-4E_



Enterprise® Laminar Flow Straddle Units,
Model EQU/06-ESUS



Airstream® Gen 3 Horizontal Laminar Flow
Cabinet, Model LHG-4AG-F_



Airstream® Gen 3 Horizontal Laminar Flow
Cabinet, Model LHS-4AG-F_



Airstream® Gen 3 Vertical Laminar Flow
Cabinet, Model LVG-4AG-S_



Airstream® Gen 3 Vertical Laminar Flow Cab-
inet, Model LVS-4AG-S_

Esco Laminar Flow Cabinets

The World's Quietest and Safest Choice for Sample Protection Needs

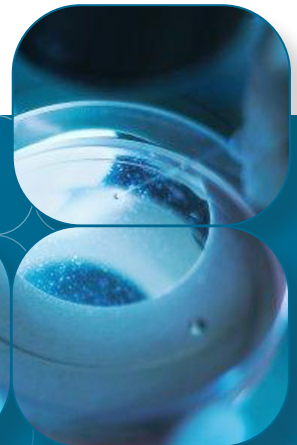

ESCO
SCIENTIFIC

Esco Laminar Flow Cabinets

Table of Contents

Corporate Profile	3
Products and Applications	4
Products Overview	5
Guide to Choosing the Right Laminar Flow Cabinet	6
Airstream® Gen 3 Horizontal Laminar Flow Cabinet	8
Airstream® Gen 3 Vertical Laminar Flow Cabinet	10
Airstream® Horizontal Laminar Flow Airflow Diagram	12
Airstream® Horizontal Laminar Flow Engineering Drawing.....	12
Airstream® Laminar Flow Accessories Table.....	12
Airstream® Vertical Laminar Flow Airflow Diagram.....	13
Airstream® Vertical Laminar Flow Engineering Drawing	13
Airstream® Laminar Flow Front Cover Table	13
LVS and LVG (-G) A-Height Specifications Table	14
LHS and LHG (-G) A-Height Specifications Table	15
LHS and LHG (-S) B-Height Specifications Table	16
LHS (-S) C-Height Specifications Table	17
LHS and LHG (-G) B-Height Specifications Table	18
LVS, LVG, LHS, and LHG (-G) C-Height Specifications Table	19
LVS and LVG (-S) A-Height Specifications Table	20
LVS (-S) C-Height Specifications Table	21
OptiMair™ Vertical Laminar Flow Cabinet	22
OptiMair™ Vertical Laminar Flow Engineering Drawing.....	24
OptiMair™ Vertical Laminar Flow Airflow Diagram.....	24
OptiMair™ Vertical Laminar Flow Applications Table	24
OptiMair™ Vertical Laminar Flow Specifications Table	25
Enterprise® Laminar Flow Straddle Units	26
Enterprise® Laminar Flow Single Straddle Units Engineering Drawing	28
Enterprise® Laminar Flow Single Straddle Units Specifications Table	28
Enterprise® Laminar Flow Double Straddle Units Engineering Drawing	29
Enterprise® Laminar Flow Double Straddle Units Specifications Table	29
Enterprise® Laminar Flow Straddle Units Airflow Diagram	30
Enterprise® Laminar Flow Straddle Units Motor Comparison	30
Enterprise® Laminar Flow Straddle Applications Table	30



Welcome to Esco Lifesciences

Esco Lifesciences' vision is to provide enabling technologies for scientific discoveries to make human lives healthier and safer.

Esco Lifesciences is committed to delivering innovative solutions for the clinical, life sciences, research, industrial, laboratory, pharmaceutical, and IVF communities. With the most extensive product line in the industry, Esco has passed a number of international standards and certifications. Esco Lifesciences represents innovation and forward-thinking designs, that are of the highest standard quality since 1978.

Availability and Accessibility. Esco Lifesciences has headquarters in Singapore, Indonesia, and Philippines, with manufacturing facilities located in Asia and Europe. Research and Development (R&D) is conducted worldwide spanning the US, Europe and Asia. Sales, services, and marketing subsidiaries are located in 42 major markets including US, UK, Japan, China and India. Esco regional distribution centers are located in Singapore, Malaysia, Thailand, Vietnam, Myanmar, Indonesia, Philippines, Bangladesh, Hong Kong, Taiwan, South Korea, China, Japan, India, UAE, Central and South Africa, Denmark, Germany, Italy, Lithuania, Russia, United Kingdom, and USA. Because of our worldwide presence, you can be sure that Esco is within your reach.

High Quality, Reliable, and Dependable. Esco Lifesciences products are of high quality, reliable, and dependable. Cross-functional teams from Esco Production, R&D, Quality Assurance, and Senior Management, are regularly assembled to review and implement areas for improvement.

Esco Lifesciences Cares for Your Safety. Esco Lifesciences focuses on providing safety not just for your samples, but also for you and the environment.

Esco Lifesciences Cares for Your Comfort. Building ergonomic designs and reducing noise levels of the units ensure comfort for our users.

Esco Lifesciences Cares for the Environment. Esco Lifesciences incorporates the latest proven technologically advanced components available. One in every four of Esco's employees is involved in Research and Development and are evaluating new components or designs for better efficiency. Whenever a new technology is available, Esco Lifesciences redesigns technology into our new products that will use lesser energy.

Customer Service and Support. Our service does not stop once purchase has been done. Esco Lifesciences gives on-time customer service such as service training, preventive maintenance, and re-certification, to respond to your equipment needs. Esco Lifesciences also offers free end-user seminars and provides educational materials and informative videos.

As Esco Lifesciences takes the opportunity to respond to the world's needs, we aim not only to contribute to the advancement of scientific discoveries but also in making the world a safer, healthier, and better place to live in.



Products and Applications

Life Sciences Laboratory Equipment

Sample Preparation

- Class I Biological Safety Cabinets
- Class II Biological Safety Cabinets
- Class II Type A2 Biological Safety Cabinets
- Class II Type B1 Biological Safety Cabinets
- Class II Type B2 Biological Safety Cabinets
- Class III Biological Safety Cabinets
- Horizontal Laminar Flow Cabinets
- Vertical Laminar Flow Cabinets
- Laboratory Animal Research Workstations
- Laboratory Centrifuges

Sample Cultivation

- CO₂ Incubators, Direct Heat Air-Jacketed
- CO₂ Incubators with Cooling System
- CO₂ Incubators with High Heat Sterilization
- Laboratory Shakers

Amplification and Detection

- Conventional Thermal Cyclers
- Microplate Shakers
- PCR Cabinets

Sample Storage & Sample Protection Solutions

- Laboratory Refrigerators and Freezers
- Ultra-low Temperature Freezers
- Remote Monitoring, Datalogging, and Programming Software
- Wireless Monitoring System

Chemical Research

- Ducted Fume Hoods
- Ductless Fume Hoods
- Filtered Storage Cabinets
- Powder Weighing Balance Enclosure
- Exhaust Blowers
- Fume Hood Airflow Monitor

General Equipment

Laboratory Thermostatic Products

- Forced Convection Laboratory Oven
- Forced Convection Laboratory Incubator
- Natural Convection Laboratory Incubator
- Refrigerated Laboratory Incubator

Medical / IVF Equipment

Innovative Time-Lapse Imaging

- MIRI® TL6 and MIRI® TL12

Embryo Culture

- MIRI® Multiroom Incubator
- MIRI® Humidity Multiroom Incubator
- Mini MIRI® Dry and Humidity Incubator
- CelCulture® CO₂ Incubator
- MIRI® II-12 Multiroom Incubator

Sample Handling

- Esco Multi-Zone ART Workstation
- MIRI® AVT
- Versati™ Tabletop Centrifuge
- Airstream® Laminar Flow Bench

Accurate Quality Control

- MIRI® GA Gas and Temperature Validation Unit

Unique Consumables

- CultureCoin®

Traceability Tool

- MIRI® Evidence

Healthcare

Esco Pharma Products

Airflow Containment

- BioBooth®
- Ceiling Laminar Airflow (CLAF)
- Cytoculture® Cytotoxic Safety Cabinet (CYT)
- Pharmacon™ Downflow Booth
- Esco Garment Storage Cabinet
- Esco Glassware Hoods
- Laminar Flow Horizontal/Vertical Trolley (LFH/VT)
- Laminar Flow Straddle Units
- Evidence Drying Cabinet

Isolation Containment

- Advanced Processing Platform Isolator (APPI)
- Aseptic Containment Isolator (ACTI)
- Blood Cell Labelling Isolator
- Streamline® Closed Restricted Access Barrier System (SLC-RABS)
- Containment Barrier Isolator (CBI)
 - CBI-Unidirectional (CBI-U)
 - CBI-Turbulent (CBI-T)
 - CBI-Class III Biosafety Cabinet (CBI-III)
 - CBI-Hybrid (CBI-H)
- Isoclean® Healthcare Platform Isolator (HPI)
 - HPI-G3-Without Filter Below Work Zone
 - HPI-G3-With Filter Below Work Zone
 - HPI-Inflatable Seal (HPI-IS)
 - HPI - Inflatable Seal - BioVap™ (HPI-IS-BVP)
- General Processing Platform Isolator (GPPI)
 - GPPI-Inflatable Seal (GPPI-IS)
 - GPPI-Static Seal (GPPI-SS)
- Streamline® Compounding Isolator (SCI)
- Streamline® Containment Isolator - Class III (SCI-III)
- Technetium Dispensing Isolator
- Turbulent Flow Aseptic Isolator™ (TFAI™)
- Weighing and Dispensing Containment Isolator (WDCI)

Cross Contamination Facility Integrated Barrier

- BioPass™ Pass Through
- Cleanroom Air Showers
- Dynamic Pass Boxes/ Dynamic Floor Laminar Hatches
- Infinity® Air Shower Pass Box
- Esco Sputum Booth
- Infinity® Pass Boxes
- Infinity® Cleanroom Transfer Hatch
- Soft Capsule® Soft Wall Cleanroom

Ventilation Containment

- Ventilated Balance Enclosure

Esco VacciXcell Products

Tide Motion Bioreactors

- CelXrocker™ (CXR)
- MiniTide®
- CelCradle™ (CC)
- CelCradle X® (CCX)
- TideXcell® (TXL)

Stirred Tank Bioreactors

- BioXcell®
- StirCradle™
- StirCradle™ PRO
- VXL™ Hybrid

Harvesting System

- CelShaker™
- CelCradle X® Semi-automated Harvester System (CCX-SAH)
- TideXcell® Harvester System (TXLHS)

Cell Culture Monitoring, Media and Consumables

- Super Plus™
- Plus™ Vero
- Plus™ MDCK
- Plus™ MDCK II
- BioNOC™ II macrocarriers
- GlucCell™ Glucose Monitoring System
- CVD Kit

Filling Line Equipment

- Traditional Filling Line
- cRABS (Closed Restricted Access Barrier System)
- oRABS (Open Restricted Access Barrier System)

Integrated Solutions

- Cell Processing Isolator (CPI)
- Cell Processing Center

Esco TaPestle Rx Products and Services

Pharmacy Automation and Compounding Supply

- Compounding Pharmacy Isolators (SCI, HPI, CBI, GPPI)
- Safety Cabinets and Enclosures (CYT, Class II BSC, VBE, LFC)
- Filling Line Isolators/RABS

Radiopharmacy Equipment

- Blood Cell Labeling Isolator
- Cytoculture® Lead-Shielded Class II Biosafety Cabinet
- Frontier® Radioisotope™ Fume Hood
- GMP-compliant Radioisotope Dispensing Isolator
- Radiopharmacy Hood (Lead Shielded Biological Safety Cabinet)
- Technetium Dispensing Isolator

Overview

For Research Laboratories

Laminar Flow Cabinets are the premium selection for discerning researchers, offering a combination of value, high quality construction, low operating noise levels, and a wide product range to suit all budgets from the industry leader. Laminar flow cabinets are used in applications where there is no generation of biohazardous materials. They are designed to provide sterile working environment for products and processes.

Airstream® Gen 3 Laminar Flow Cabinets

Airstream® Laminar Flow Cabinets are designed to provide superior product protection for your samples in research laboratories by preventing the entry of room and airborne contaminants. They are built with the latest laminar flow technology and innovation, and offers a wide range of options for user preferences.

- Horizontal Laminar Flow Cabinet
- Vertical Laminar Flow Cabinet

OptiMair™ Vertical Laminar Flow Cabinets

OptiMair™ Vertical Laminar Flow Cabinets provide an ISO Class 3 air cleanliness within the work zone per ISO 14644.1, which is significantly cleaner than the usual Class 5 classification. Like all Esco products, OptiMair™ laminar flow cabinets are manufactured for the most demanding laboratory applications and designed for maximum chemical resistance and enhanced durability for a long service life.

For Industrial Process Protection

Enterprise® Laminar Flow Straddle Units

Enterprise® Laminar Flow Straddle Units are designed for larger-scale process protection in industrial applications typically requiring multiple units connected in an assembly line configuration. Esco straddle units provide ISO Class 4 air cleanliness within the work zone as per ISO 14644.1.

Airstream® Gen 3 Horizontal Laminar Flow Cabinet (Tempered Glass and Stainless Steel Side Walls)

Esco Airstream® Horizontal Laminar Flow Cabinet is built with the latest laminar flow technology and innovation to provide superior product protection for your samples and processes. It is powered by the latest generation DC ECM blower that saves up to 70% of energy compared to AC motor and offers stable airflow despite voltage fluctuation. Other key features include ULPA filtration system that creates ISO Class 3 work zone, Isocide™ antimicrobial coating that inhibits bacterial growth within 24 hours of exposure, Sentinel™ Gold microprocessor controller, and many more.

Enjoy the benefits of product protection with more product variants and sizes to suit more applications and user preferences.

Key features:

- Energy-efficient DC ECM blower
- ULPA filter (ISO Class 3 work-zone)
- Sentinel™ Gold microprocessor control system
- Isocide™ antimicrobial powder coating
- Standby mode for more energy savings
- Stable and self-compensating airflow
- Real-time airflow monitoring
- With fixed sash and sliding sash option

Esco is the world leader in premium laminar flow cabinets. They are the premium selection for the discerning researchers and scientists due to their low operating noise levels, and a wide range of features.

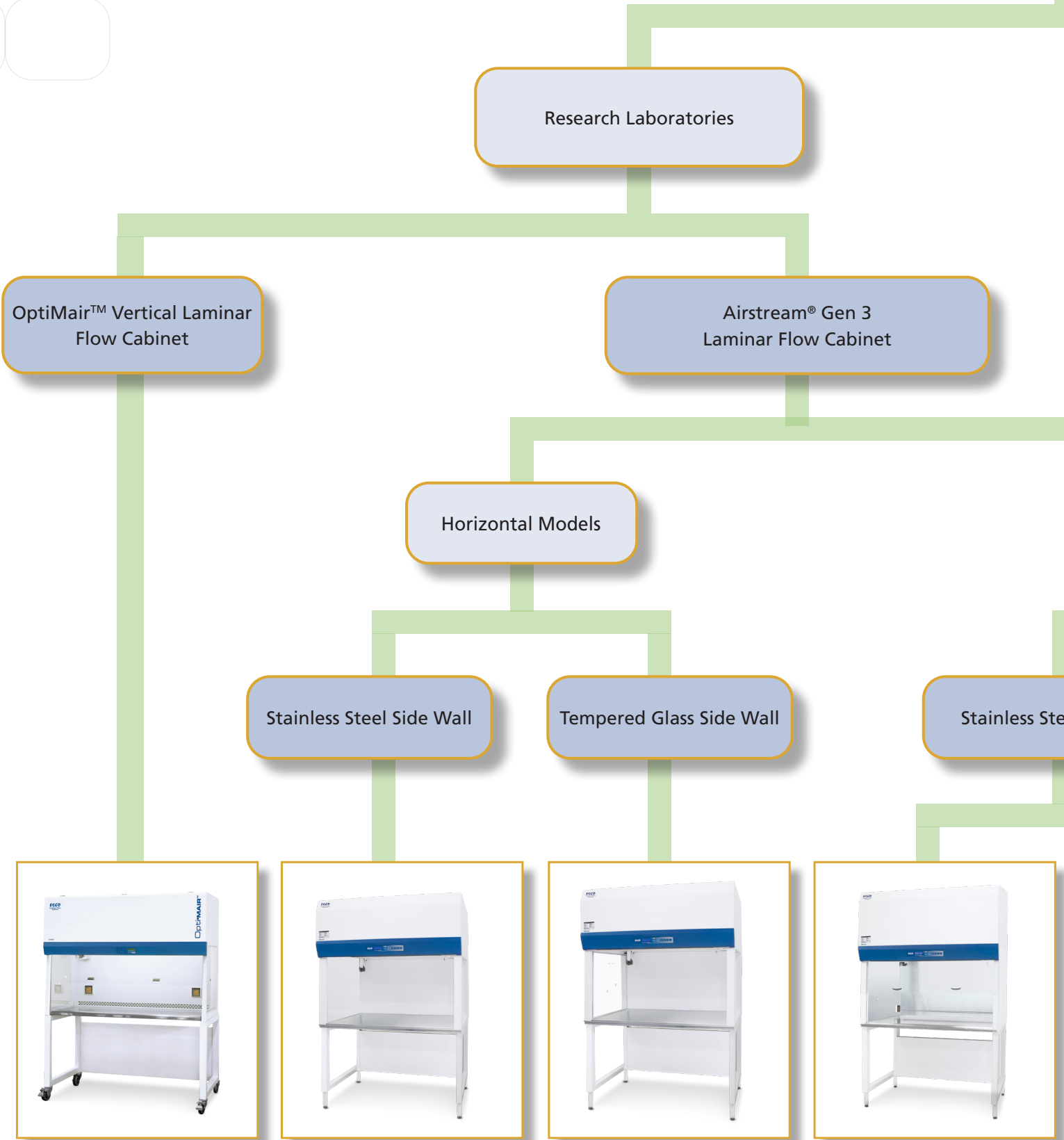

OptiMair™, Model ACB-4E_



Airstream® Gen 3, Model LHS-4AG-F_



Airstream® Gen 3, Model LHG-4AG-F_



Airstream® Gen 3, Model LVS-4AG-S_

Flow Cabinets

inets for the global industrial and life sciences market. operator, offering a combination of value, high quality construction, de product range to suit all budgets.

Industrial Processes

Enterprise® Laminar Flow Straddle Units

Vertical Models

el Side Wall

Tempered Glass Side Wall



Airstream® Gen 3, Model LVS-4AG-F_

Airstream® Gen 3, Model LVG-4AG-S_

Airstream® Gen 3, Model LVG-4AG-F_

Enterprise®, Model EQU/06-ESUS

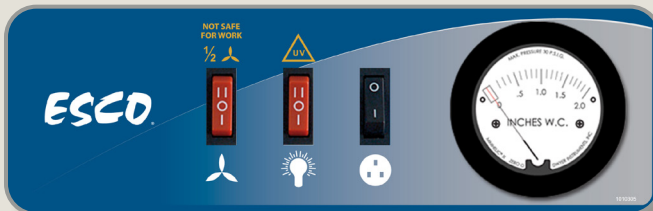

Rocker Switches

- Easy-to-use switches
- Displays filter loading status
- Manually adjustable UV timer

Note: Rocker switch models are available in USA only

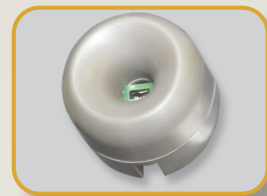

Sentinel™ Gold Microprocessor Controller

- Displays all safety information on one screen
- Standby mode for more energy savings
- Programmable UV timer to extend the UV lamp lifespan



Ergonomic Control Panel Location

- Centered and angled down an easy reach & viewing



Work Top

- Spill-retaining work top designed with a recessed central area to contain accidental liquid spills

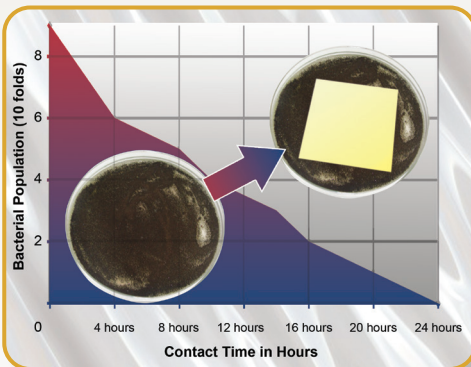

Isocide™ Antimicrobial Coating

- Silver-ion impregnated powder coat
- Inhibits the microbial growth to improve safety

Guide to Models																						
1st Placeholder Product Line	2nd Placeholder Flow	3rd Placeholder Side Wall	4th Placeholder Width	5th Placeholder Internal Height	6th Placeholder Control	7th Placeholder Window	8th Placeholder Electrical															
Laminar Flow	L	Horizontal	H	Tempered Glass	G	3 feet	3	2 feet	A	Sentinel™ Gold	G	Fixed Sash	F	230 VAC, 50 / 60 Hz	8							
		Stainless Steel	S	4 feet	4	2.5 feet	B	3 feet	C	Rocker Switches	S			115 VAC, 50 / 60 Hz	9							
				5 feet	5	3 feet	C															
				6 feet	6																	
				8 feet	8																	

Example Code: LHG-4BG-F8

Specifications: Laminar flow cabinet, Horizontal Flow, Glass sided walls, 4 ft width, 2.5 ft internal height, Sentinel™ Gold microprocessor controller, Fixed window and 230 VAC, 50/60 Hz

Airflow Sensor

- Real-time airflow monitoring system
- Alerts the user if the airflow is insufficient

Energy-efficient DC ECM Blower

- Powered by latest generation DC ECM that is more efficient than legacy ECM and VFD motors
- 70% energy savings compared to AC motor
- Stable airflow despite building voltage fluctuations & filter loading
- Standby mode that provides ISO Class 5 work-zone

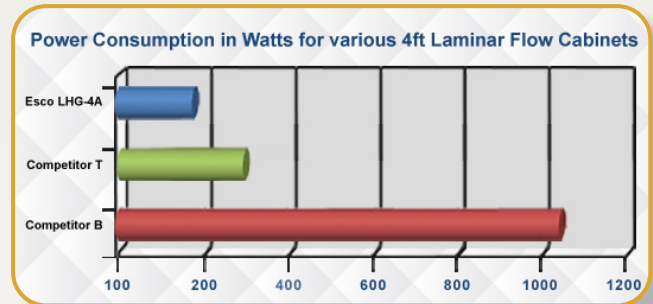
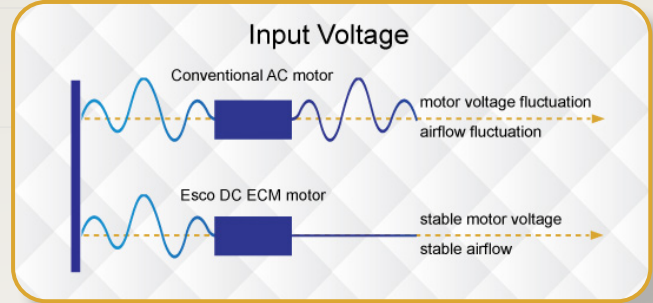

ULPA Filter

- 10x filtration efficiency than of HEPA filter, creates an ISO Class 3 work-zone instead of the industry-standard ISO Class 5
- 10x cleaner work-zone than cabinets with HEPA filter

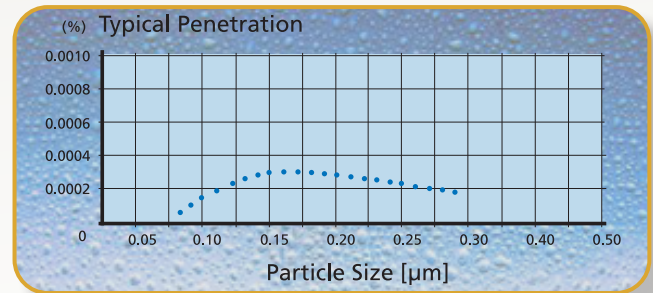

Airstream® Gen 3 Horizontal Laminar Flow Cabinet, Model LHG-4AG-F_

Quiet Operation

- Comfortable low noise emission at 55 dBA
**LHG-4B in an open field condition*
- Reduces fatigue and improves work concentration

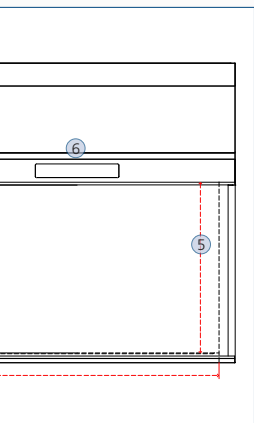

	Cabinet Performance	Air Quality	Filtration	Electrical Safety
Standards Compliance	IEST-RP-CC002.2, Worldwide	ISO 14644.1, Class 3, Worldwide AS 1386 Class 1.5, Australia JIS B9920, Class 3, Japan	EN-1822 (H14), Europe IEST-RP-CC001.3, Worldwide IEST-RP-CC007, Worldwide IEST-RP-CC034.1, Worldwide	IEC61010-1, Worldwide EN 61010-1, Europe UL61010-1, USA CAN/CSA-22.2, No.61010-1

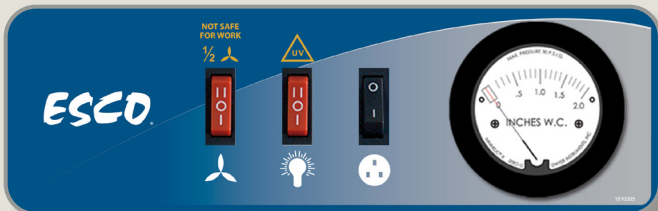

Rocker Switches

- Easy-to-use switches
- Displays filter loading status
- Manually adjustable UV timer

Note: Rocker switch models are available in USA only

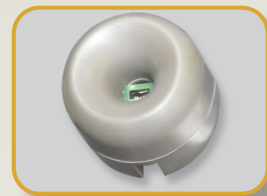

Sentinel™ Gold Microprocessor Controller

- Displays all safety information on one screen
- Standby mode for more energy-savings
- Programmable UV timer to extend the UV lamp lifespan



Ergonomic Control Panel Location

- Centered and angled down for an easy reach & viewing



Work Top

- Spill-retaining work top designed with a recessed central area to contain accidental liquid spills

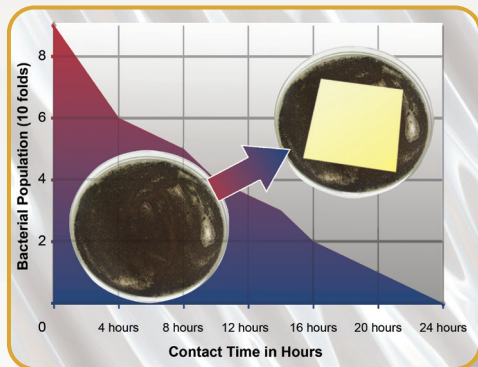

Isocide™ Antimicrobial Coating

- Silver-ion impregnated powder coat
- Inhibits the microbial growth to improve safety



Airstream® Gen 3 Vertical Laminar Flow Cabinet, Model LVG-4AG-S_

Guide to Models

1st Placeholder Product Line	2nd Placeholder Flow	3rd Placeholder Side Wall	4th Placeholder Width	5th Placeholder Internal Height	6th Placeholder Control	7th Placeholder Window	8th Placeholder Electrical
Laminar Flow	L	Tempered Glass	3 feet	2.25 feet	Sentinel™ Gold	Fixed Sash	230 VAC, 50 / 60 Hz
		Stainless Steel	4 feet	3 feet	Rocker Switches	Sliding Sash	115 VAC, 50 / 60 Hz
			5 feet				
			6 feet				
			8 feet				

Airflow Sensor

- Real-time airflow monitoring system
- Alerts the user if the airflow is insufficient

Energy-efficient DC ECM Blower

- Powered by latest generation DC ECM that is more efficient than legacy ECM and VFD motors
- 70% energy savings compared to AC motor
- Stable airflow despite building voltage fluctuations & filter loading
- Standby mode that provides ISO Class 5 work-zone

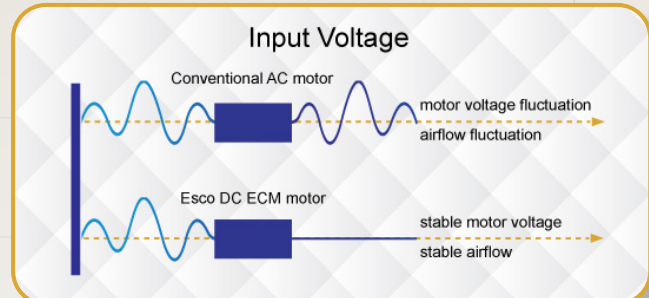

Power Consumption in Watts for various 4ft Laminar Flow Cabinets

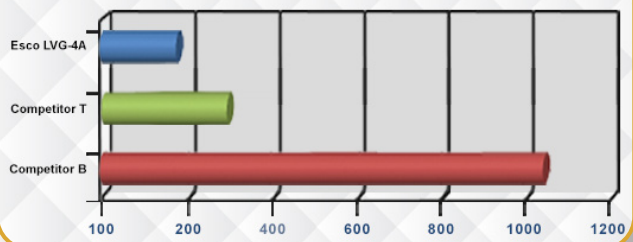

ULPA Filter

- 10x filtration efficiency than of HEPA filter, creates an ISO Class 3 work-zone instead of industry-standard ISO Class 5
- 10x cleaner work-zone than cabinets with HEPA filter

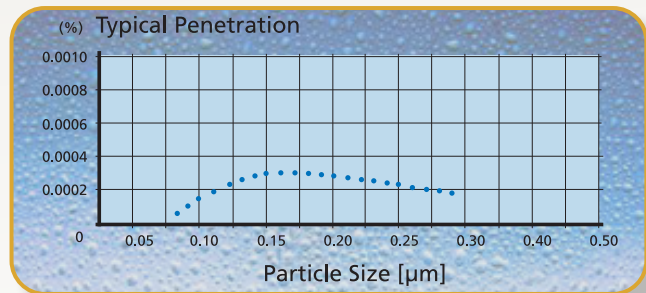

Sash Window Options

- Polycarbonate fixed sash
- Manual sliding sash made of UV-resistant tempered glass

Quiet Operation

- Comfortable low noise emission at 52 dBA
**LVG-4AG-F_ in an open field condition*
- Reduces fatigue and improves work concentration

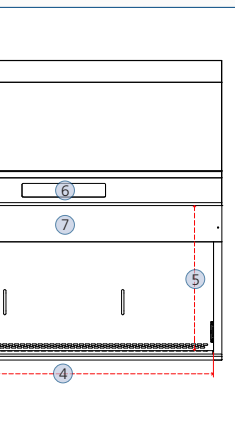

	Cabinet Performance	Air Quality	Filtration	Electrical Safety
Standards Compliance	IEST-RP-CC002.2, Worldwide	ISO 14644.1, Class 3, Worldwide AS 1386 Class 1.5, Australia JIS B9920, Class 3, Japan	EN-1822 (H14), Europe IEST-RP-CC001.3, Worldwide IEST-RP-CC007, Worldwide IEST-RP-CC034.1, Worldwide	IEC61010-1, Worldwide EN 61010-1, Europe UL61010-1, USA CAN/CSA-22.2, No.61010-1

Airstream® Horizontal Laminar Flow Stainless Steel Side Wall Version



- Room air is drawn in from the top of the cabinet through a disposable pre-filter with 85% arrestance, trapping larger particles and prolonging the life of the main filter.
- Air is forced evenly across the ULPA/H14 filter. The result is a stream of clean laminar air within the work-zone, diluting and flushing contaminants present in the interior. The purified air travels in a horizontal, unidirectional stream towards the open front of the cabinet.
- A nominal filter face velocity of 0.45 m/s or 90 fpm ensures that there is a sufficient number of air changes within the enclosed area of the cabinet to maintain the cleanliness.

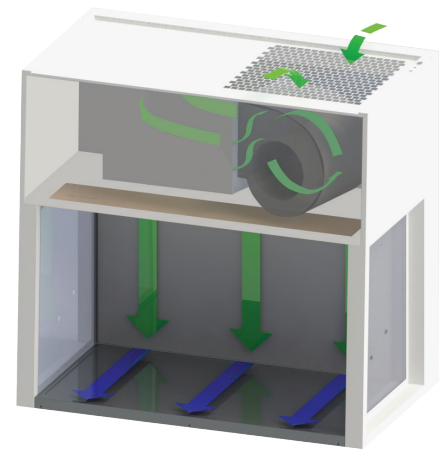

■ ULPA-filtered air
■ Room air / Inflow air

Airstream® Horizontal Laminar Flow Engineering Drawing

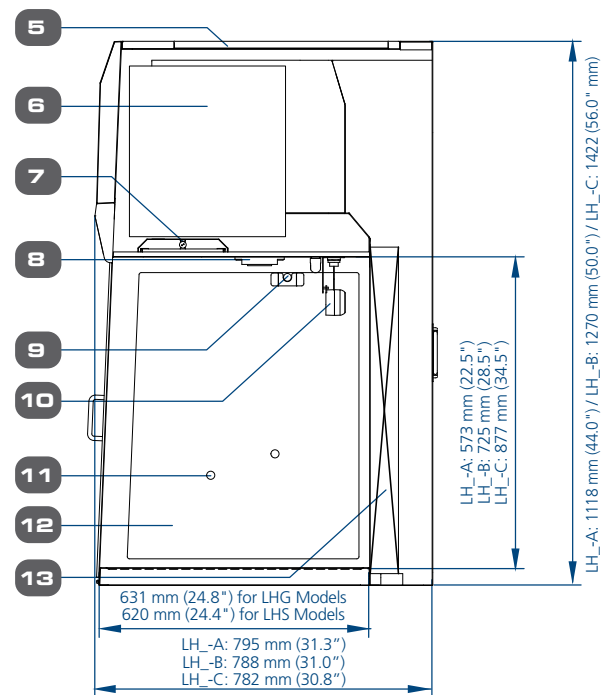
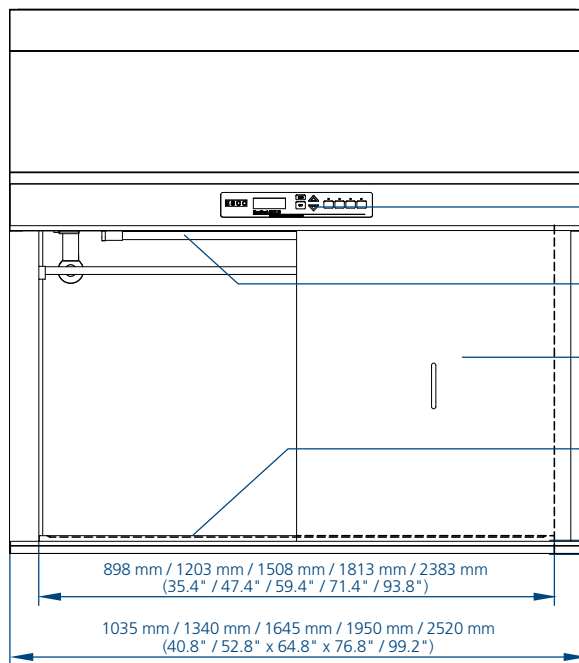

- Esco Sentinel™ Gold Microprocessor Controller / Simple Switches Control System
- UV Light Retrofit Kit Provision

- (Optional) Front Cover
- Spill-retaining Stainless Steel Work Top
- Pre-filter
- DC ECM Blower

- LED Lamp
- Electrical Outlet Provision (maximum of 2)
- IV Bar Retrofit Kit Provision
- Air Flow Sensor

- Service Fixture Retrofit Kit Provision (2 on each side)
- Tempered Glass Side Walls (for LHG Variant)
Stainless Steel Side Walls (for LHS Variant)
- ULPA / H14 Filter

Esco Horizontal and Vertical Laminar Flow Cabinet Accessories

Model	3 feet Width	4 feet Width	5 feet Width	6 feet Width	8 feet Width
UV Lamp	UV-15A-L 5170251		UV-30A-L 5170255		UV-30A-L *2
Electrical Outlet	EO-				
IV Bar Horizontal Flow	IV-890 5170608	IV-1195 5170609	IV-1500 5170610	IV-1805 5170611	IV-2375 5170662
IV Bar Vertical Flow	IV-960 5170603	IV-1265 5170604	IV-1570 5170605	IV-1875 5170606	IV-2445 5170607
PVC Arm Rest	ME-W-REST 5170127				
Height-adjustable Lab Chair (Blue)	ME-LD-AR360 1150006				
Ergonomic Foot Rest	FT-REST 5170073				
Support Stand Telescoping with Castors (28" to 34")	STC-3A0 5130055	STC-4A0 5130056	STC-5A0 5130057	STC-6A0 5130058	STC-8A0 Gen2 5131146
Support Stand Telescoping with Leveling Feet (28" to 34")	STL-3A0 5130050	STL-4A0 5130051	STL-5A0 5130052	STL-6A0 5130053	STL-8A0 Gen2 5131150
Support Stand with Leveling Feet (28")	SAL-3A0 Gen2 5130170	SAL-4A0 Gen2 5130134	SAL-5A0 Gen2 5130171	SAL-6A0 Gen2 5130172	SAL-8A0 Gen2 5131124
Support Stand with Leveling Feet (34")	SAL-3B0 Gen2 5130174	SAL-4B0 Gen2 5130175	SAL-5B0 Gen2 5130176	SAL-6B0 Gen2 5130177	SAL-8B0 Gen2 5131125
Pre-filter	Horizontal	PF-4 5090003	PF-2 (2 pcs) 5090001	PF-3 and PF-4 5090002 and 5090003	PF-2 (3 pcs) 5090001
	Vertical				PF-4 (2 pcs) 5090003
					PF-2 and PF-4 (2 pcs) 5090001 and 5090003

Airstream® Vertical Laminar Flow Stainless Steel Side Wall Version



- Room air drawn in from the top of the cabinet through a disposable pre-filter with 85% arrestance, trapping larger particles and prolonging the life of the main filter.
- Air is forced evenly across the ULPA/H14 filter. The result is a stream of clean laminar air with the work-zone, diluting and flushing contaminants present in the interior. The purified air travels in a vertical, unidirectional stream towards the open front and back of the cabinet.
- A nominal filter face velocity of 0.45 m/s or 90 fpm ensures that there is a sufficient number of air changes within the enclosed area of the clean bench to maintain cleanliness.

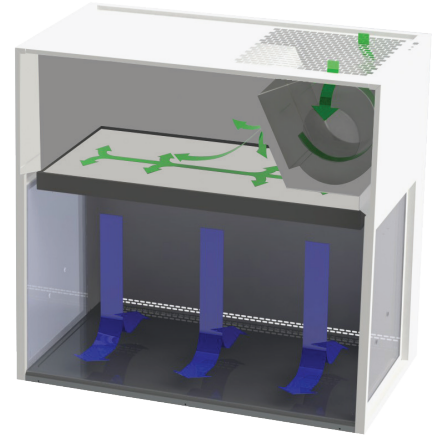

■ ULPA-filtered air
■ Room air / Inflow air

Airstream® Vertical Laminar Flow Engineering Drawing

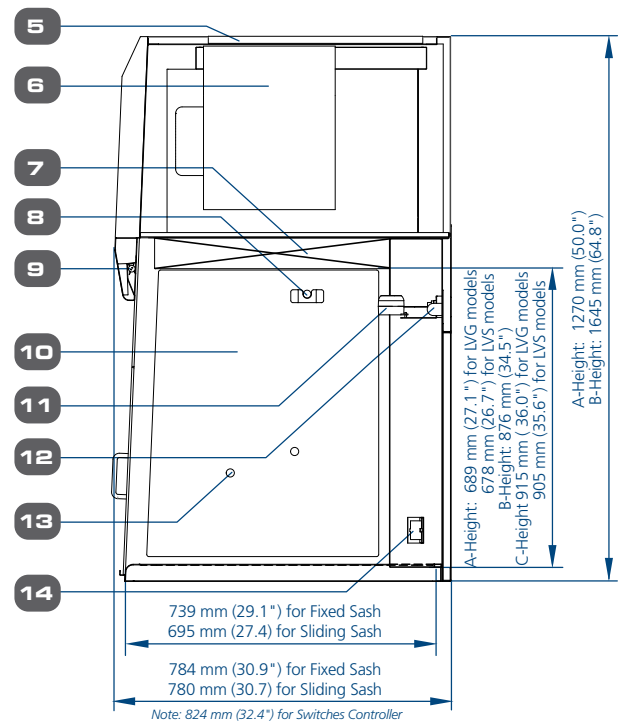
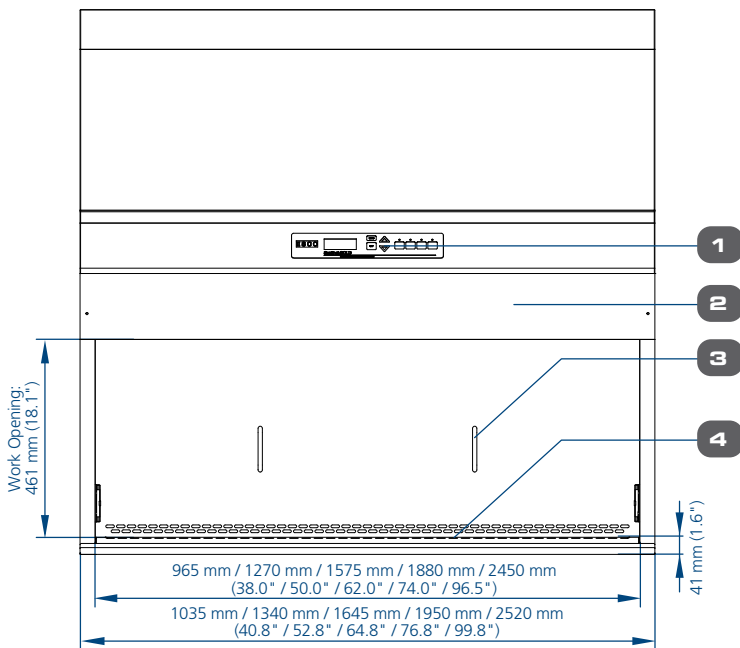

- Esco Sentinel™ Gold Microprocessor Control System / Simple Switches Control System
- Fixed Sash (LV_-F variant)
(Optional) Manual Sliding Sash (LV_-S variant)
- Optional Front Cover
- Stainless Steel Work Top
- Pre-filter

- DC ECM Blower (Self-compensating and lower noise)
- ULPA filter
- IV Bar Retrofit Kit Provision
- LED Lamp
- Tempered Glass Side Walls (for LVG Variant)
Stainless Steel Side Walls (for LVS Variant)

- Airflow Sensor
- UV Lamp
- Service Fixture Retrofit Kit Provision (2 holes on each side)
- Electrical Outlet Retrofit Kit provision (1 outlet on each side)

Esco Horizontal and Vertical Laminar Flow Cabinets Front Cover

	3 feet	4 feet	5 feet	6 feet	8 feet
LHG / LHS	FC-LHG / LHS-3A 5170601	FC-LHG / LHS-4A 5170602	FC-LHG / LHS-5A 5170585	FC-LHG / LHS-6A 5170586	
	FC-LHG / LHS-3B 5170587	FC-LHG / LHS-4B 5170588	FC-LHG / LHS-5B 5170589	FC-LHG / LHS-6B 5170590	
	FC-LHG / LHS-3C 5170627	FC-LHG / LHS-4C 5170591		FC-LHG / LHS-6C 5170592	FC-LHG / LHS-8C 5170593
LVG / LVS*	FC-LVG / LVS-3A 5170595	FC-LVG / LVS-4A 5170584	FC-LVG / LVS-5A 5170596	FC-LVG / LVS-6A 5170597	
		FC-LVG / LVS-4C 5170598	FC-LVG / LVS-5C 5170061	FC-LVG / LVS-6C 5170599	FC-LVG / LVS-8C 5170600

* For fixed sash models only (LVS_-F and LVG_-F)

**General Specifications, Airstream® Vertical Laminar Flow Cabinet, A-Height (Interior Height: 2.25 ft / 0.7 m)
with Sentinel™ Gold Microprocessor Control System**

Stainless Steel Sides		LVS-3AG-F8 2120381	LVS-4AG-F8 2120382	LVS-5AG-F8 2120383	LVS-6AG-F8 2120384
		LVS-3AG-S8 2120796	LVS-4AG-S8 2120759	LVS-5AG-S8 2120766	LVS-6AG-S8 2120760
		LVS-3AG-F9 2120443	LVS-4AG-F9 2120445	LVS-5AG-F9 2120447	LVS-6AG-F9 2120449
		LVS-3AG-S9 2120797	LVS-4AG-S9 2120762	LVS-5AG-S9 2120767	LVS-6AG-S9 2120764
Glass Sides		LVG-3AG-F8 2120374	LVG-4AG-F8 2120369	LVG-5AG-F8 2120375	LVG-6AG-F8 2120407
		LVG-3AG-S8 2120792	LVG-4AG-S8 2120701	LVG-5AG-S8 2120755	LVG-6AG-S8 2120703
		LVG-3AG-F9 2120435	LVG-4AG-F9 2120437	LVG-5AG-F9 2120439	LVG-6AG-F9 2120441
		LVG-3AG-S9 2120795	LVG-4AG-S9 2120761	LVG-5AG-S9 2120768	LVG-6AG-S9 2120763
Nominal Size		0.9 meter (3')	1.2 meter (4')	1.5 meter (5')	1.8 meter (6')
External Dimensions without Base Stand (W x D x H)	Fixed Sash Models	1035 x 784 x 1270 mm (40.8" x 30.9" x 50.0")	1340 x 784 x 1270 mm (52.8" x 30.9" x 50.0")	1645 x 784 x 1270 mm (64.8" x 30.9" x 50.0")	1950 x 784 x 1270 mm (76.8" x 30.9" x 50.0")
	Sliding Sash Models	1035 x 780 x 1270 mm (40.8" x 30.7" x 50.0")	1340 x 780 x 1270 mm (52.8" x 30.7" x 50.0")	1645 x 780 x 1270 mm (64.8" x 30.7" x 50.0)	1950 x 780 x 1270 mm (76.8" x 30.7" x 50.0")
Internal Work Area, Dimensions (W x D x H)	LVG Models (Fixed Sash)	965 x 739 x 689 mm (38.0" x 29.1" x 27.1")	1270 x 739 x 689 mm (50.0" x 29.1" x 27.1")	1575 x 739 x 689 mm (62.0" x 29.1" x 27.1")	1880 x 739 x 689 mm (74.0" x 29.1" x 27.1")
	LVG Models (Sliding Sash)	965 x 695 x 689 mm (38.0" x 27.0" x 27.1")	1270 x 695 x 689 mm (50.0" x 27.0" x 27.1")	1575 x 695 x 689 mm (62.0" x 27.3" x 27.1")	1880 x 695 x 689 mm (74.0" x 27" x 27.1")
	LVS Models (Fixed Sash)	965 x 739 x 678 mm (38.0" x 29.1" x 26.7")	1270 x 739 x 678 mm (50.0" x 29.1" x 26.7")	1575 x 739 x 678 mm (62.0" x 29.1" x 26.7")	1880 x 739 x 678 mm (74.0" x 29.1" x 26.7")
	LVS Models (Sliding Sash)	965 x 695 x 678 mm (38.0" x 27.0" x 26.7")	1270 x 695 x 678 mm (50.0" x 27.0" x 26.7")	1575 x 695 x 678 mm (62.0" x 27.3" x 26.7")	1880 x 695 x 678 mm (74.0" x 27" x 26.7")
Internal Work Area, Space		0.6 m ² (6.5 ft ²)	0.8 m ² (8.6 ft ²)	1.0 m ² (10.7 ft ²)	1.3 m ² (14.0 ft ²)
Average Airflow Velocity		0.45 m/s (90 fpm) at initial setpoint			
Air Volume		1117 m ³ /hr (657 cfm)	1471 m ³ /hr (866 cfm)	1824 m ³ /hr (1074 cfm)	2177 m ³ /hr (1281 cfm)
ULPA Filter Typical Efficiency		> 99.999% at particle size between 0.1 to 0.3 µm			
Sound Emission per IEST-RP-CC002.2*		51.6 dBA	52.4 dBA	55.6 dBA	57.6 dBA
LED Lamp Intensity at Zero Ambient		1000 Lux (93 foot candles)			
Cabinet Construction	Main Body	1.2 mm (0.05") 18-gauge electro-galvanized steel with white oven-baked epoxy-polyester powder-coated finish			
	Work Zone	1.2 mm (0.05") 18-gauge stainless steel, grade 304, with 4B finish			
	Side Walls	LVS Models: 1.2 mm (0.05") 18 gauge stainless steel, grade 304, with 4B finish			
		LVG Models: UV Resistant tempered glass, 5 mm (0.2"), colorless and transparent			
Sash Window	Fixed Sash: 5 mm (0.2") UV Resistant Polycarbonate Sash with 461 mm (18.1") opening				
	Manual Sliding Sash: 5 mm (0.2") UV Resistant Tempered Glass with counter-balance system and ergonomic handle				
Electrical Power Rating 8: 220-240 VAC, 50 / 60 Hz, 1 phase	Cabinet Full Load Amps (FLA)	7.3 A	7.5 A	7.8 A	8.5 A
	Optional Outlets (FLA)	5 A			
	Cabinet Nominal Power (W)	129	151	199	258
	Heat Rejected, BTU per Hour	440	515	679	880
Electrical Power Rating 9: 110-130 VAC, 50 / 60 Hz, 1 phase	Cabinet Full Load Amps (FLA)	12 A	12.5 A	13.3 A	13.5 A
	Optional Outlets (FLA)	5 A			
	Cabinet Nominal Power (W)	132	155	204	264
	Heat Rejected, BTU per Hour	450	529	696	908
Net Weight**		135 Kg (298 lbs)	158 Kg (348 lbs)	199 Kg (438 lbs)	208 Kg (459 lbs)
Shipping Weight**		167 Kg (368 lbs)	202 Kg (445 lbs)	256 Kg (564 lbs)	273 Kg (602 lbs)
Shipping Dimensions, Maximum (W x D x H)**		1120 x 900 x 1590 mm (44" x 35" x 62")	1400 x 900 x 1590 mm (55" x 35" x 62")	1720 x 900 x 1590 mm (68" x 35" x 62")	2200 x 900 x 1590 mm (87" x 35" x 62")
Shipping Volume, Maximum**		1.6 m ³ (56.6 ft ³)	2.0 m ³ (70.6 ft ³)	2.5 m ³ (88.2 ft ³)	3.3 m ³ (116.5 ft ³)

Specifications are subject to change without notice.

*Noise reading in open field condition / anechoic chamber. Noise reading in normal room varies by room size, layout, and background noise, but may reach roughly 3 dBA above these values.

**Cabinet only, excludes optional stand.

**General Specifications, Airstream® Horizontal Laminar Flow Cabinet, A-Height (Interior Height: 2 ft / 0.6 m)
with Sentinel™ Gold Microprocessor Control System**

		LHS-3AG-F8 2120377	LHS-4AG-F8 2120378	LHS-5AG-F8 2120379	LHS-6AG-F8 2120380
Stainless Steel Sides		LHS-3AG-F8 2120377	LHS-4AG-F8 2120378	LHS-5AG-F8 2120379	LHS-6AG-F8 2120380
		LHS-3AG-F9 2120425	LHS-4AG-F9 2120427	LHS-5AG-F9 2120429	LHS-6AG-F9 2120431
Glass Sides		LHG-3AG-F8 2120387	LHG-4AG-F8 2120368	LHG-5AG-F8 2120372	LHG-6AG-F8 2120373
		LHG-3AG-F9 2120417	LHG-4AG-F9 2120419	LHG-5AG-F9 2120421	LHG-6AG-F9 2120423
Nominal Size		0.9 meter (3')	1.2 meter (4')	1.5 meter (5')	1.8 meter (6')
External Dimensions (W x D x H)	Without Base Stand	1035 x 795 x 1118 mm (40.8" x 31.3" x 44.0")	1340 x 795 x 1118 mm (52.8" x 31.3" x 44.0")	1645 x 795 x 1118 mm (64.8" x 31.3" x 44.0")	1955 x 795 x 1118 mm (76.8" x 31.3" x 44.0")
	Internal Work Area, Dimensions (W x D x H)	LHG Models	898 x 631 x 573 mm (35.4" x 24.8" x 22.5")	1203 x 631 x 573 mm (47.4" x 24.8" x 22.5")	1508 x 631 x 573 mm (59.4" x 24.8" x 22.5")
LHS Models		898 x 620 x 573 mm (35.4" x 24.4" x 22.5")	1203 x 620 x 573 mm (47.4" x 24.4" x 22.5")	1508 x 620 x 573 mm (59.4" x 24.4" x 22.5")	1813 x 620 x 573 mm (71.4" x 24.4" x 22.5")
Internal Work Area, Space		0.5 m ² (5.4 ft ²)	0.7 m ² (7.5 ft ²)	0.9 m ² (9.6 ft ²)	1.0 m ² (10.8 ft ²)
Average Airflow Velocity		0.45 m/s (90 fpm) at initial setpoint			
Air Volume		834 m ³ /hr (491 cfm)	1117 m ³ /hr (657 cfm)	1400 m ³ /hr (824 cfm)	1683 m ³ /hr (911 cfm)
ULPA Filter Typical Efficiency		> 99.999% at particle size between 0.1 to 0.3 µm			
Sound Emission per IEST-RP-CC002.2*		53.2 dBA	55.8 dBA	58.4 dBA	60.0 dBA
LED Lamp Intensity at Zero Ambient		1045 Lux (97 foot candles)	1139 Lux (106 foot candles)	984 Lux (91 foot candles)	1221 Lux (113 foot candles)
Cabinet Construction	Main Body	1.2 mm (0.05") 18-gauge electro-galvanized steel with white oven-baked epoxy-polyester powder-coated finish			
	Work Zone	1.2 mm (0.05") 18-gauge stainless steel, grade 304, with 4B finish			
	Side Walls	LHS Models: 1.2 mm (0.05") 18 gauge stainless steel, grade 304, with 4B finish LHG Models: UV absorbing tempered glass, 5 mm (0.2"), colorless and transparent			
Electrical Power Rating 8: 220-240 VAC, 50 / 60 Hz, 1 phase	Cabinet Full Load Amps (FLA)	7 A	7.3 A	7.6 A	8 A
	Optional Outlets (FLA)	5 A			
	Cabinet Nominal Power (W)	140	171	211	249
	Heat Rejected, BTU per Hour	478	583	720	850
Electrical Power Rating 9: 110-130 VAC, 50 / 60 Hz, 1 phase	Cabinet Full Load Amps (FLA)	11.3 A	11.4 A	11.4 A	11.5 A
	Optional Outlets (FLA)	5 A			
	Cabinet Nominal Power (W)	144	175	216	255
	Heat Rejected, BTU per Hour	491	597	737	870
Net Weight**		100 Kg (220 lbs)	145 Kg (320 lbs)	167 Kg (368 lbs)	212 Kg (467 lbs)
Shipping Weight**		132 Kg (291 lbs)	200 Kg (440 lbs)	224 Kg (494 lbs)	277 Kg (611 lbs)
Shipping Dimensions, Maximum (W x D x H)**		1120 x 900 x 1590 mm (44" x 35" x 62")	1400 x 900 x 1590 mm (55" x 35" x 62")	1720 x 900 x 1590 mm (68" x 35" x 62")	2200 x 900 x 1590 mm (87" x 35" x 62")
Shipping Volume, Maximum**		1.6 m ³ (56.6 ft ³)	2.0 m ³ (70.6 ft ³)	2.5 m ³ (88.2 ft ³)	3.3 m ³ (116.5 ft ³)

Specifications are subject to change without notice.

*Noise reading in open field condition / anechoic chamber. Noise reading in normal room varies by room size, layout, and background noise, but may reach roughly 3 dBA above these values.

**Cabinet only, excludes optional stand.

**General Specifications, Airstream® Horizontal Laminar Flow Cabinet, B-Height (Interior Height: 2 ½ ft / 0.8 m)
with Simple Switches Control System**

Glass Side, Simple Switches		LHG-3BS-F9 2120705	LHG-4BS-F9 2120716	LHG-5BS-F9 2120717	LHG-6BS-F9 2120718
Stainless Steel Side, Simple Switches		LHS-3BS-F9 2120661	LHS-4BS-F9 2120663	LHS-5BS-F9 2120665	LHS-6BS-F9 2120667
Nominal Size		0.9 meter (3')	1.2 meter (4')	1.5 meter (5')	1.8 meter (6')
External Dimensions (W x D x H)	Without Base Stand	1035 x 788 x 1270 mm (40.8" x 31.0" x 50.0")	1340 x 788 x 1270 mm (52.8" x 31.0" x 50.0")	1645 x 788 x 1270 mm (64.8" x 31.0" x 50.0")	1950 x 788 x 1270 mm (76.8" x 31.0" x 50.0")
	Internal Work Area, Dimensions (W x D x H)*	898 x 620 x 725 mm (35.4" x 24.4" x 28.5")	1203 x 620 x 725 mm (47.4" x 24.4" x 28.5")	1508 x 620 x 725 mm (59.4" x 24.4" x 28.5")	1813 x 620 x 725 mm (71.4" x 24.4" x 28.5")
Internal Work Area, Space		0.5 m ² (5.4 ft ²)	0.7 m ² (7.5 ft ²)	0.9 m ² (9.6 ft ²)	1.0 m ² (10.8 ft ²)
Average Airflow Velocity		0.45 m/s (90 fpm) at initial setpoint			
Air Volume		1055 m ³ /hr (621 cfm)	1413 m ³ /hr (832 cfm)	1771 m ³ /hr (1042 cfm)	2129 m ³ /hr (1253 cfm)
ULPA Filter Typical Efficiency		> 99.999% at particle size between 0.1 to 0.3 µm			
Sound Emission per IEST-RP-CC002.2*		52.8 dBA	55.4 dBA	58.0 dBA	59.6 dBA
LED Lamp Intensity at Zero Ambient		1279 Lux (119 foot candles)	1394 Lux (130 foot candles)	1204 Lux (112 foot candles)	1494 Lux (139 foot candles)
Cabinet Construction	Main Body	1.2 mm (0.05") 18-gauge electro-galvanized steel with white oven-baked epoxy-polyester powder-coated finish.			
	Work Zone	1.2 mm (0.05") 18-gauge stainless steel, grade 304, with 4B finish.			
	LHG Side Walls	UV-absorbing tempered glass, 5 mm (0.2"), colorless and transparent			
	LHS Side Walls	Interior: 1.2 mm (0.05") 18-gauge stainless steel, grade 304, with 4B finish. Exterior: 1.2 mm (0.05") 18 gauge electro-galvanized steel with white oven-baked epoxy-polyester powder-coated finish.			
Electrical Power Rating 9: 110-130 VAC, 50 / 60Hz, 1 phase**	Cabinet Full Load Amps (FLA)	12.3 A	12.4 A	12.4 A	12.5 A and 6.5 A (2 Power Inlet)
	Optional Outlets (FLA)	6 A			
	Cabinet Nominal Power (W)	154	188	273	343
	Heat Rejected, BTU per Hour	525	641	932	1170
Net Weight***		108 Kg (238 lbs)	156 Kg (344 lbs)	180 Kg (397 lbs)	228 Kg (503 lbs)
Shipping Weight***		140 Kg (308 lbs)	211 Kg (465 lbs)	237 Kg (522 lbs)	293 Kg (646 lbs)
Shipping Dimensions, Maximum (W x D x H)***		1120 x 900 x 1590 mm (44" x 35" x 62")	1400 x 900 x 1590 mm (55" x 35" x 62")	1720 x 900 x 1590 mm (68" x 35" x 62")	2200 x 900 x 1590 mm (87" x 35" x 62")
Shipping Volume, Maximum***		1.6 m ³ (56.6 ft ³)	2.0 m ³ (70.6 ft ³)	2.5 m ³ (87 ft ³)	3.3 m ³ (118.6 ft ³)

Specifications are subject to change without notice.

*Noise reading in open field condition / anechoic chamber. Noise reading in normal room varies by room size, layout, and background noise, but may reach roughly 3 dBA above these values.

** Additional voltages may be available; contact Esco for ordering information.

*** Cabinet only; excludes optional stand.

**General Specifications, Airstream® Horizontal Laminar Flow Cabinet, C-Height (Interior Height: 3 ft / 0.9 m)
with Simple Switches Control System**

Stainless Steel Side, Simple Switches		LHS-4CS-F9 2120675	LHS-6CS-F9 2120679	LHS-8CS-F9 2120681
Nominal Size		1.2 meter (4')	1.8 meter (6')	2.4 meter (8')
External Dimensions (W x D x H)	Without Base Stand	1340 x 782 x 1422 mm (52.8" x 30.8" x 56.0")	1950 x 782 x 1422 mm (76.8" x 30.8" x 56.0")	2520 x 782 x 1422 mm (99.2" x 30.8" x 56.0")
Internal Work Area, Dimensions (W x D x H)*		1203 x 620 x 877 mm (47.4" x 24.4" x 34.5")	1813 x 620 x 877 mm (71.4" x 24.4" x 34.5")	2383 x 620 x 877 mm (93.8" x 24.4" x 34.5")
Internal Work Area, Space		0.7 m ² (7.5 ft ²)	1.0 m ² (10.8 ft ²)	1.4 m ² (15.0 ft ²)
Average Airflow Velocity		0.45 m/s (90 fpm) at initial set point		
Air Volume		1709 m ³ /hr (1006 cfm)	2576 m ³ /hr (1516 cfm)	3385 m ³ /hr (1992 cfm)
ULPA Filter Typical Efficiency		> 99.999% at particle size between 0.1 to 0.3 µm		
Sound Emission per IEST-RP-CC002.2*		56.4 dBA	59.4 dBA	62.3 dBA
LED Lamp Intensity At Zero Ambient		1304 Lux (121 foot candles)	1001 Lux (93 foot candles)	1136 Lux (106 foot candles)
Cabinet Construction	Main Body	1.2 mm (0.05") 18-gauge electro-galvanized steel with white oven-baked epoxy-polyester powder-coated finish.		
	Work Zone	1.2 mm (0.05") 18-gauge stainless steel, grade 304, with 4B finish.		
	LHS Side Walls	Interior: 1.2 mm (0.05") 18-gauge stainless steel, grade 304, with 4B finish. Exterior: 1.2 mm (0.05") 18 gauge electro-galvanized steel with white oven-baked epoxy-polyester powder-coated finish.		
Electrical Power Rating 9: 110-130 VAC, 50 / 60Hz, 1 phase**	Cabinet Full Load Amps (FLA)	12.3 A	12.5 A and 6.5 A (2 Power Inlet)	13 A and 7 A (2 Power Inlet)
	Optional Outlets (FLA)	6 A		
	Cabinet Nominal Power (W)	217	400	432
	Heat Rejected, BTU per Hour	740	1365	1481
Net Weight***		167 Kg (368 lbs)	236 Kg (520 lbs)	317 Kg (699 lbs)
Shipping Weight***		222 Kg (489 lbs)	301 Kg (663 lbs)	397 Kg (875 lbs)
Shipping Dimensions, Maximum (W x D x H)***		1400 x 900 x 1590 mm (55" x 35" x 62")	2200 x 900 x 1590 mm (87" x 35" x 62")	2720 x 950 x 1590 mm (107" x 37" x 62")
Shipping Volume, Maximum***		2.0 m ³ (70.6 ft ³)	3.3 m ³ (118.6 ft ³)	4.1 m ³ (144.8 ft ³)

Specifications are subject to change without notice.

*Noise reading in open field condition / anechoic chamber. Noise reading in normal room varies by room size, layout, and background noise, but may reach roughly 3 dBA above these values.

**Additional voltages may be available; contact Esco for ordering information.

***Cabinet only; excludes optional stand.

**General Specifications, Airstream® Horizontal Laminar Flow Cabinet, B-Height (Interior Height: 2.5 ft / 0.8 m)
with Sentinel™ Gold Microprocessor Control System**

Stainless Steel Sides		LHS-3BG-F8 2120463	LHS-4BG-F8 2120465	LHS-5BG-F8 2120467	LHS-6BG-F8 2120469
Glass Sides		LHG-3BG-F8 2120453	LHG-4BG-F8 2120455	LHG-5BG-F8 2120457	LHG-6BG-F8 2120459
Without Base Stand		1035 x 788 x 1270 mm (40.8" x 31.0" x 50.0")	1340 x 788 x 1270 mm (52.8" x 31.0" x 50.0")	1645 x 788 x 1270 mm (64.8" x 31.0" x 50.0")	1950 x 788 x 1270 mm (76.8" x 31.0" x 50.0")
Internal Work Area, Dimensions (W x D x H)	LHG Models	898 x 631 x 725 mm (35.4" x 24.8" x 28.5")	1203 x 631 x 725 mm (47.4" x 24.8" x 28.5")	1508 x 631 x 725 mm (59.4" x 24.8" x 28.5")	1813 x 631 x 725 mm (71.4" x 24.8" x 28.5")
	LHS Models	898 x 620 x 725 mm (35.4" x 24.4" x 28.5")	1203 x 620 x 725 mm (47.4" x 24.4" x 28.5")	1508 x 620 x 725 mm (59.4" x 24.4" x 28.5")	1813 x 620 x 725 mm (71.4" x 24.4" x 28.5")
Internal Work Area, Space		0.5 m ² (5.4 ft ²)	0.7 m ² (7.5 ft ²)	0.9 m ² (9.6 ft ²)	1.0 m ² (10.8 ft ²)
Average Airflow Velocity		0.45 m/s (90 fpm) at initial setpoint			
Air Volume		1055 m ³ /hr (621 cfm)	1413 m ³ /hr (832 cfm)	1771 m ³ /hr (1042 cfm)	2129 m ³ /hr (1253 cfm)
ULPA Filter Typical Efficiency		> 99.999% at particle size between 0.1 to 0.3 µm			
Sound Emission per IEST-RP-CC002.2*		52.8 dBA	55.4 dBA	58.0 dBA	59.6 dBA
LED Lamp Intensity at Zero Ambient		1279 Lux (119 foot candles)	1394 Lux (130 foot candles)	1204 Lux (112 foot candles)	1494 Lux (139 foot candles)
Cabinet Construction	Main Body	1.2 mm (0.05") 18-gauge electro-galvanized steel with white oven-baked epoxy-polyester powder-coated finish			
	Work Zone	1.2 mm (0.05") 18-gauge stainless steel, grade 304, with 4B finish			
	Side Walls	LHS Models: 1.2 mm (0.05") 18 gauge stainless steel, grade 304, with 4B finish LHG Models: UV absorbing tempered glass, 5 mm (0.2"), colorless and transparent			
Electrical Power Rating 8: 220-240 VAC, 50 / 60 Hz, 1 phase	Cabinet Full Load Amps (FLA)	7 A	7.3 A	7.6 A	8 A and 3 A (2 Power Inlet)
	Optional Outlets (FLA)	5 A			
	Cabinet Nominal Power (W)	160	207	255	302
	Heat Rejected, BTU per Hour	546	702	870	1030
Electrical Power Rating 9: 110-130 VAC, 50 / 60 Hz, 1 phase	Cabinet Full Load Amps (FLA)	11.3 A	11.4 A	11.4 A	11.5 A and 6.5 A (2 Power Inlet)
	Optional Outlets (FLA)	5 A			
	Cabinet Nominal Power (W)	163	211	260	308
	Heat Rejected, BTU per Hour	556	720	887	1051
Net Weight**		108 Kg (238 lbs)	156 Kg (344 lbs)	180 Kg (397 lbs)	228 Kg (503 lbs)
Shipping Weight**		140 Kg (308 lbs)	200 Kg (441 lbs)	237 Kg (522 lbs)	293 Kg (646 lbs)
Shipping Dimensions, Maximum (W x D x H)**		1120 x 900 x 1590 mm (44" x 35" x 62")	1400 x 900 x 1590 mm (55" x 35" x 62")	1720 x 900 x 1590 mm (68" x 35" x 62")	2200 x 900 x 1590 mm (87" x 35" x 62")
Shipping Volume, Maximum**		1.6 m ³ (56.6 ft ³)	2.0 m ³ (70.6 ft ³)	2.5 m ³ (88.2 ft ³)	3.3 m ³ (116.5 ft ³)

Specifications are subject to change without notice.

*Noise reading in open field condition / anechoic chamber. Noise reading in normal room varies by room size, layout, and background noise, but may reach roughly 3 dBA above these values.

**Cabinet only, excludes optional stand.

General Specifications, Airstream® Horizontal and Vertical Laminar Flow Cabinet, C-Height (Interior Height: 3 ft / 0.9 m) with Sentinel™ Gold Microprocessor Control System

Model	Nominal Size	External Dimension (W x D x H)	Internal Dimension (W x D x H)	Sound Emission per IEST-RP-CC002.2*	LED Lamp Intensity at Zero Ambient	Cabinet Full Load Amps (FLA)	Cabinet Nominal Power (W)	Heat Rejected, BTU per Hour	Shipping Weight**	Shipping Dimensions, Maximum (W x D x H)**	Shipping Volume, Maximum**
VERTICAL LAMINAR FLOW (Power Rating 8: 220-240 VAC, 50 / 60 Hz, 1 phase)											
LVS-4CG-F8 2120565	4 ft (1.2 m)	1340 x 774 x 1645 mm (52.8" x 30.5" x 64.8")	1270 x 739 x 905 mm (50.0" x 29.1" x 35.6")	52.5 dBA	904 Lux (84 fc)	7.5 A	213	727	243 Kg (536 lbs)	1490 x 900 x 1750 mm (58.7" x 35.4" x 68.9")	2.3 m³ (81.2 ft³)
LVS-6CG-F8 2120569	6 ft (1.8 m)	1950 x 774 x 1645 mm (76.8" x 30.5" x 64.8")	1880 x 739 x 905 mm (74.0" x 29.1" x 35.6")	53.2 dBA	1062 Lux (99 fc)	8.5 A	392	1337	330 Kg (661 lbs)	2070 x 900 x 1750 mm (81.5" x 35.4" x 68.9")	3.3 m³ (116.5 ft³)
LVS-8CG-F8 2120686	8 ft (2.4 m)	2520 x 774 x 1645 mm (99.2" x 30.5" x 64.8")	2450 x 739 x 905 mm (96.5" x 29.1" x 35.6")	59.8 dBA	1100 Lux (102 fc)	8.5 A and 3.5 A	422	1446	455 Kg (1003 lbs)	2720 x 950 x 1750 mm (107" x 37.4" x 68.9")	4.5 m³ (158.9 ft³)
LVG-4CG-F8 2120555	4 ft (1.2 m)	1340 x 774 x 1645 mm (52.8" x 30.5" x 64.8")	1270 x 739 x 915 mm (50.0" x 29.1" x 36.0")	52.5 dBA	904 Lux (84 fc)	7.5 A	213	727	243 Kg (536 lbs)	1490 x 900 x 1750 mm (58.7" x 35.4" x 68.9")	2.3 m³ (81.2 ft³)
LVG-6CG-F8 2120559	6 ft (1.8 m)	1950 x 774 x 1645 mm (76.8" x 30.5" x 64.8")	1880 x 739 x 915 mm (74.0" x 29.1" x 36.0")	53.2 dBA	1062 Lux (99 fc)	8.5 A	392	1337	330 Kg (661 lbs)	2070 x 900 x 1750 mm (81.5" x 35.4" x 68.9")	3.3 m³ (116.5 ft³)
VERTICAL LAMINAR FLOW (Power Rating 9: 110-130 VAC, 50 / 60 Hz, 1 phase)											
LVS-4CG-F9 2120605	4 ft (1.2 m)	1340 x 774 x 1645 mm (52.8" x 30.5" x 64.8")	1270 x 739 x 905 mm (50.0" x 29.1" x 35.6")	52.5 dBA	904 Lux (84 fc)	11.5 A	217	741	243 Kg (536 lbs)	1490 x 900 x 1750 mm (58.7" x 35.4" x 68.9")	2.3 m³ (81.2 ft³)
LVS-6CG-F9 2120609	6 ft (1.8 m)	1950 x 774 x 1645 mm (76.8" x 30.5" x 64.8")	1880 x 739 x 905 mm (74.0" x 29.1" x 35.6")	53.2 dBA	1062 Lux (99 fc)	13.5 A	400	1365	330 Kg (661 lbs)	2070 x 900 x 1750 mm (82" x 35.4" x 68.9")	3.3 m³ (116.5 ft³)
LVS-8CG-F9 2120687	8 ft (2.4 m)	2520 x 774 x 1645 mm (99.2" x 30.5" x 64.8")	2450 x 739 x 905 mm (96.5" x 29.1" x 35.6")	59.8 dBA	1100 Lux (102 fc)	14 A and 8A	434	1481	455 Kg (1003 lbs)	2720 x 950 x 1750 mm (107" x 37.4" x 68.9")	4.5 m³ (158.9 ft³)
LVG-4CG-F9 2120595	4 ft (1.2 m)	1340 x 774 x 1645 mm (52.8" x 30.5" x 64.8")	1270 x 739 x 915 mm (50.0" x 29.1" x 36.0")	52.5 dBA	904 Lux (84 fc)	11.5 A	217	741	243 Kg (536 lbs)	1490 x 900 x 1750 mm (58.7" x 35.4" x 68.9")	2.3 m³ (81.2 ft³)
LVG-6CG-F9 2120599	6 ft (1.8 m)	1950 x 774 x 1645 mm (76.8" x 30.5" x 64.8")	1880 x 739 x 915 mm (74.0" x 29.1" x 36.0")	53.2 dBA	1062 Lux (99 fc)	13.5 A	400	1365	330 Kg (661 lbs)	2070 x 900 x 1750 mm (81.5" x 35.4" x 68.9")	3.3 m³ (116.5 ft³)
HORIZONTAL LAMINAR FLOW (Power Rating 8: 220-240 VAC, 50 / 60 Hz, 1 phase)											
LHS-4CG-F8 2120545	4 ft (1.2 m)	1340 x 782 x 1422 mm (52.8" x 30.8" x 56.0")	1203 x 620 x 877 mm (47.4" x 24.4" x 34.5")	56.4 dBA	934 Lux (87 fc)	7.3 A	246	840	222 Kg (489 lbs)	1400 x 900 x 1590 mm (55.1" x 35.4" x 62.5")	2.0 m³ (70.6 ft³)
LHS-6CG-F8 2120549	6 ft (1.8 m)	1950 x 782 x 1422 mm (76.8" x 30.8" x 56.0")	1813 x 620 x 877 mm (71.4" x 24.4" x 34.5")	59.4 dBA	1001 Lux (93 fc)	8 A and 3 A	359	1225	301 Kg (664 lbs)	2200 x 900 x 1590 mm (86.6" x 35.4" x 62.5")	3.3 m³ (116.5 ft³)
LHS-8CG-F8 2120704	8 ft (2.4 m)	2520 x 782 x 1422 mm (99.2" x 30.8" x 56.0")	2383 x 620 x 877 mm (93.8" x 24.4" x 34.5")	62.3 dBA	1136 Lux (106 fc)	8.3 A and 3.3 A	388	1324	397 Kg (875 lbs)	2720 x 950 x 1590 mm (107.0" x 37.4" x 62.5")	4.1 m³ (144.8 ft³)
LHG-3CG-F8 2120533	3 ft (0.9 m)	1035 x 782 x 1422 mm (40.8" x 30.8" x 56.0")	898 x 631 x 877 mm (35.4" x 24.8" x 34.5")	54.2 dBA	1195 Lux (111 fc)	7 A	190	648	147 Kg (324 lbs)	1120 x 900 x 1590 mm (44" x 35.4" x 62.5")	1.6 m³ (56.5 ft³)
LHG-4CG-F8 2120535	4 ft (1.2 m)	1340 x 782 x 1422 mm (52.8" x 30.8" x 56.0")	1203 x 631 x 877 mm (47.4" x 24.8" x 34.5")	56.4 dBA	934 Lux (87 fc)	7.3 A	246	840	222 Kg (489 lbs)	1400 x 900 x 1590 mm (55.1" x 35.4" x 62.5")	2.0 m³ (70.6 ft³)
LHG-6CG-F8 2120539	6 ft (1.8 m)	1950 x 782 x 1422 mm (76.8" x 30.8" x 56.0")	1813 x 631 x 877 mm (71.4" x 24.8" x 34.5")	59.4 dBA	1001 Lux (93 fc)	8 A and 3 A	359	1225	301 Kg (664 lbs)	2200 x 900 x 1590 mm (86.6" x 35.4" x 62.5")	3.3 m³ (116.5 ft³)
HORIZONTAL LAMINAR FLOW (Power Rating 9: 110-130 VAC, 50 / 60 Hz, 1 phase)											
LHS-4CG-F9 2120585	4 ft (1.2 m)	1340 x 782 x 1422 mm (52.8" x 30.8" x 56.0")	1203 x 620 x 877 mm (47.4" x 24.4" x 34.5")	56.4 dBA	934 Lux (87 fc)	11.4 A	250	853	222 Kg (489 lbs)	1400 x 900 x 1590 mm (55.1" x 35.4" x 68.9")	2.0 m³ (70.6 ft³)
LHS-6CG-F9 2120589	6 ft (1.8 m)	1950 x 782 x 1422 mm (76.8" x 30.8" x 56.0")	1813 x 620 x 877 mm (71.4" x 24.4" x 34.5")	59.4 dBA	1001 Lux (93 fc)	11.5 A and 6.5 A	365	1245	301 Kg (664 lbs)	2200 x 900 x 1590 mm (86.6" x 35.4" x 62.5")	3.3 m³ (116.5 ft³)
LHS-8CG-F9 2120719	8 ft (2.4 m)	2520 x 782 x 1422 mm (99.2" x 30.8" x 56.0")	2383 x 620 x 877 mm (93.8" x 24.4" x 34.5")	62.3 dBA	1136 Lux (106 fc)	12 A and 6 A	394	1344	397 Kg (875 lbs)	2720 x 950 x 1590 mm (107.0" x 37.4" x 62.5")	4.1 m³ (144.8 ft³)
LHG-3CG-F9 2120573	3 ft (0.9 m)	1035 x 782 x 1422 mm (40.8" x 30.8" x 56.0")	898 x 631 x 877 mm (35.4" x 24.8" x 34.5")	54.2 dBA	1195 Lux (111 fc)	11.3 A	193	659	147 Kg (324 lbs)	1120 x 900 x 1590 mm (44" x 35.4" x 62.5")	1.6 m³ (56.5 ft³)
LHG-4CG-F9 2120575	4 ft (1.2 m)	1340 x 782 x 1422 mm (52.8" x 30.8" x 56.0")	1203 x 631 x 877 mm (47.4" x 24.8" x 34.5")	56.4 dBA	934 Lux (87 fc)	11.4 A	250	853	222 Kg (489 lbs)	1400 x 900 x 1590 mm (55.1" x 35.4" x 62.5")	2.0 m³ (70.6 ft³)
LHG-6CG-F9 2120579	6 ft (1.8 m)	1950 x 782 x 1422 mm (76.8" x 30.8" x 56.0")	1813 x 631 x 877 mm (71.4" x 24.8" x 34.5")	59.4 dBA	1001 Lux (93 fc)	11.5 A and 6.5 A	365	1245	301 Kg (664 lbs)	2200 x 900 x 1590 mm (86.6" x 35.4" x 62.5")	3.3 m³ (116.5 ft³)
SPECIFICATIONS AVAILABLE FOR ALL MODELS AND SIZES											
Cabinet Construction	Main Body	1.2 mm (0.05") 18 gauge electro-galvanized steel with white oven-baked epoxy-polyester powder-coated finish									
	Work Zone	1.2 mm (0.05") 18-gauge stainless steel, grade 304, with 4B finish									
	Side Walls	LVG-LHG: UV absorbing tempered glass, 5 mm (0.2"), colorless and transparent									
LVS-LHS: 1.2 mm (0.05") 18 gauge stainless steel, grade 304, with 4B finish											
Average Airflow Velocity			0.45 m/s (90 fpm) at initial set point								
ULPA Filter Typical Efficiency			> 99.999% at particle size between 0.1 to 0.3 µm								
Electrical			Power Rating 8: 220-240 VAC, 50 / 60 Hz, 1 phase								
			Power Rating 9: 110-130 VAC, 50 / 60 Hz, 1 phase								

Specifications are subject to change without notice.

*Noise reading in open field condition / anechoic chamber. Noise reading in normal room varies by room size, layout, and background noise, but may reach roughly 3 dBA above these values.

**Cabinet only, excludes optional stand.

**General Specifications, Airstream® Vertical Laminar Flow Cabinet, A-Height (Interior Height: 2 ¼ ft / 0.7 m)
with Simple Switches Control System**

Glass Side, Simple Switches		LVS-3AS-F9 2120706	LVS-4AS-F9 2120707	LVS-5AS-F9 2120708	LVS-6AS-F9 2120709
Stainless Steel Side, Simple Switches		LVG-3AS-F9 2120712	LVG-4AS-F9 2120713	LVG-5AS-F9 2120714	LVG-6AS-F9 2120715
Nominal Size		0.9 meter (3')	1.2 meter (4')	1.5 meter (5')	1.8 meter (6')
External Dimensions (W x D x H)	Without Base Stand	1035 x 824 x 1270 mm (40.8" x 32.4" x 50.0")	1340 x 824 x 1270 mm (52.8" x 32.4" x 50.0")	1645 x 824 x 1270 mm (64.8" x 32.4" x 50.0")	1950 x 824 x 1270 mm (76.8" x 32.4" x 50.0")
	Internal Work Area, Dimensions (W x D x H)*	965 x 739 x 689 mm (38.0" x 29.1" x 27.1")	1270 x 739 x 689 mm (50.0" x 29.1" x 27.1")	1575 x 739 x 689 mm (62.0" x 29.1" x 27.1")	1880 x 739 x 689 mm (74.0" x 29.1" x 27.1")
	LVS Models	965 x 739 x 678 mm (38.0" x 29.1" x 26.7")	1270 x 739 x 678 mm (50.0" x 29.1" x 26.7")	1575 x 739 x 678 mm (62.0" x 29.1" x 26.7")	1880 x 739 x 678 mm (74.0" x 29.1" x 26.7")
Internal Work Area, Space		0.6 m ² (6.5 ft ²)	0.8 m ² (8.6 ft ²)	1.0 m ² (10.7 ft ²)	1.3 m ² (14.0 ft ²)
Average Airflow Velocity		0.45 m/s (90 fpm) at initial setpoint			
Air Volume		1117 m ³ /hr (657 cfm)	1471 m ³ /hr (866 cfm)	1824 m ³ /hr (1074 cfm)	2177 m ³ /hr (1281 cfm)
ULPA Filter Typical Efficiency		> 99.999% at particle size between 0.1 to 0.3 µm			
Sound Emission per IEST-RP-CC002.2*		51.6 dBA	52.4 dBA	55.6 dBA	57.6 dBA
LED Lamp Intensity at Zero Ambient		980 Lux (94 foot candles)	904 Lux (84 foot candles)	894 Lux (83 foot candles)	1062 Lux (99 foot candles)
Cabinet Construction	Main Body	1.2 mm (0.05") 18-gauge electro-galvanized steel with white oven-baked epoxy-polyester powder-coated finish.			
	Work Zone	1.2 mm (0.05") 18-gauge stainless steel, grade 304, with 4B finish.			
	LVG Side Walls	UV-absorbing tempered glass, 5 mm (0.2"), colorless and transparent			
	LVS Side Walls	Interior: 1.2 mm (0.05") 18-gauge stainless steel, grade 304, with 4B finish. Exterior: 1.2 mm (0.05") 18 gauge electro-galvanized steel with white oven-baked epoxy-polyester powder-coated finish.			
Electrical Power Rating 9: 110-130 VAC, 50 / 60Hz, 1 phase**	Cabinet Full Load Amps (FLA)	13 A	13.5 A	14.3 A	14.5 A
	Optional Outlets (FLA)	6 A			
	Cabinet Nominal Power (W)	132	155	204	264
	Heat Rejected, BTU per Hour	450	529	696	908
Net Weight***		135 Kg (298 lbs)	158 Kg (348 lbs)	199 Kg (438 lbs)	208 Kg (459 lbs)
Shipping Weight***		167 Kg (368 lbs)	202 Kg (445 lbs)	256 Kg (564 lbs)	273 Kg (602 lbs)
Shipping Dimensions, Maximum (W x D x H)***		1120 x 900 x 1590 mm (44" x 35" x 62")	1400 x 900 x 1590 mm (55" x 35" x 62")	1720 x 900 x 1590 mm (68" x 35" x 62")	2200 x 900 x 1590 mm (87" x 35" x 62")
Shipping Volume, Maximum***		1.6 m ³ (56.6 ft ³)	2.0 m ³ (70.6 ft ³)	2.5 m ³ (88.2 ft ³)	3.3 m ³ (116.5 ft ³)

Specifications are subject to change without notice.

*Noise reading in open field condition / anechoic chamber. Noise reading in normal room varies by room size, layout, and background noise, but may reach roughly 3 dBA above these values.

**Additional voltages may be available; contact Esco for ordering information.

***Cabinet only; excludes optional stand.

**General Specifications, Airstream® Vertical Laminar Flow Cabinet, C-Height (Interior Height: 3 ft / 0.9 m)
with Simple Switches Control System**

Stainless Side, Simple Switches		LVS-4CS-F9 2120710	LVS-5CS-F9 2120720	LVS-6CS-F9 2120711	LVS-8CS-F9 2120689
Nominal Size		1.2 meter (4')	1.5 meter (5')	1.8 meter (6')	2.4 meters (8')
External Dimensions (W x D x H)	Without Base Stand	1340 x 814 x 1645 mm (52.8" x 32.0" x 64.8")	1645 x 814 x 1645 mm (64.8" x 32.0" x 64.8")	1950 x 814 x 1645 mm (76.8" x 32.0" x 64.8")	2520 x 814 x 1645 mm (99.2" x 32.0" x 64.8")
	Internal Work Area, Dimensions (W x D x H)*	1270 x 739 x 905 mm (50.0" x 29.1" x 35.6")	1575 x 739 x 905 (62.0" x 29.1" x 35.6")	1880 x 739 x 905 mm (74.0" x 29.1" x 35.6")	2450 x 739 x 905 mm (96.5" x 29.1" x 35.6")
Internal Work Area, Space		0.8 m ² (8.6 ft ²)	1.0 m ² (10.7 ft ²)	1.3 m ² (14.0 ft ²)	1.6 m ² (17.2 ft ²)
Average Airflow Velocity		0.45 m/s (90 fpm) at initial setpoint			
Air Volume		1432 m ³ /hr (843 cfm)	1776 m ³ /hr (1045 cfm)	2120 m ³ /hr (1248 cfm)	2762 m ³ /hr (1626 cfm)
ULPA Filter Typical Efficiency		> 99.999% at particle size between 0.1 to 0.3 µm			
Sound Emission per IEST-RP-CC002.2*		52.6 dBA	53.0 dBA	53.2 dBA	59.8 dBA
LED Lamp Intensity At Zero Ambient		904 Lux (84 foot candles)	894 Lux (83 foot candles)	1062 Lux (99 foot candles)	1100 Lux (8102 foot candles)
Cabinet Construction	Main Body	1.2 mm (0.05") 18-gauge electro-galvanized steel with white oven-baked epoxy-polyester powder-coated finish.			
	Work Zone	1.2 mm (0.05") 18-gauge stainless steel, grade 304, with 4B finish.			
	LVS Side Walls	Interior: 1.2 mm (0.05") 18-gauge stainless steel, grade 304, with 4B finish. Exterior: 1.2 mm (0.05") 18 gauge electro-galvanized steel with white oven-baked epoxy-polyester powder-coated finish.			
Electrical Power Rating 9: 110-130 VAC, 50 / 60Hz, 1 phase**	Cabinet Full Load Amps (FLA)	13.5 A	14.3 A	14.5 A and 8.5 A (2 Power Inlet)	15 A and 9 A (2 Power Inlet)
	Optional Outlets (FLA)	5 A			
	Cabinet Nominal Power (W)	217	304	400	434
	Heat Rejected, BTU per Hour	740	1037	1365	1481
Net Weight***		194 Kg (428 lbs)	244 Kg (538 lbs)	255 Kg (560 lbs)	352 Kg (776 lbs)
Shipping Weight***		243 Kg (536 lbs)	308 Kg (679 lbs)	330 Kg (661 lbs)	455 Kg (1003 lbs)
Shipping Dimensions, Maximum (W x D x H)***		1490 x 900 x 1750 mm (59" x 35" x 69")	1790 x 900 x 1750 mm (70" x 35" x 69")	2070 x 900 x 1750 mm (82" x 35" x 69")	2720 x 950 x 1750 mm (107" x 37" x 69")
Shipping Volume, Maximum***		2.3 m ³ (81 ft ³)	2.8 m ³ (99.6 ft ³)	3.3 m ³ (116.5 ft ³)	4.5 m ³ (158.9 ft ³)

Specifications are subject to change without notice.

*Noise reading in open field condition / anechoic chamber. Noise reading in normal room varies by room size, layout, and background noise, but may reach roughly 3 dBA above these values.

**Additional voltages may be available; contact Esco for ordering information.

***Cabinet only; excludes optional stand.

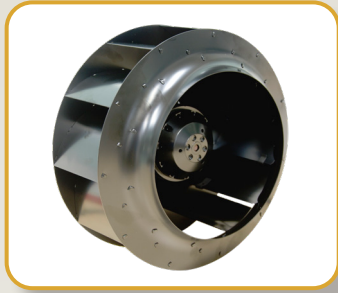

AC Blower

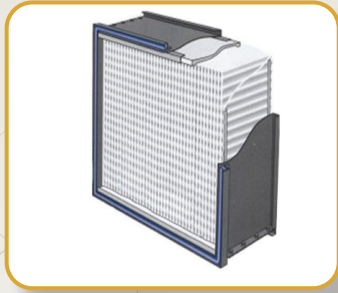

ULPA Filter



Tempered Glass Side Wall

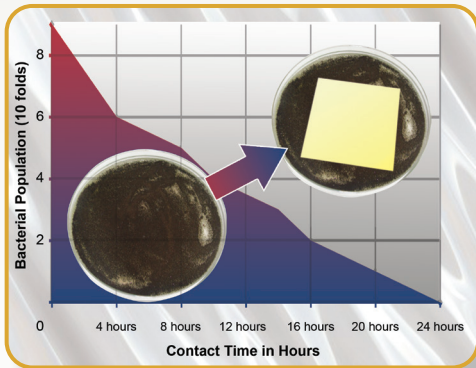

Isocide™ Antimicrobial Powder Coating



Auto-Purge Slots

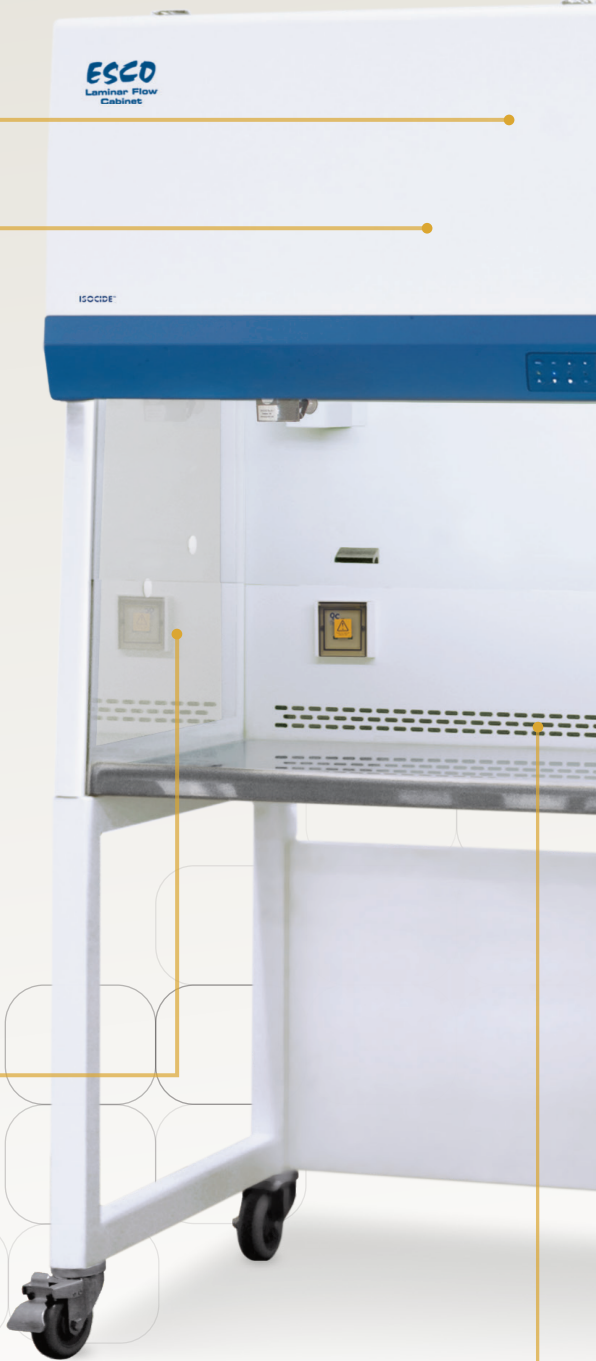

*OptiMair™ Vertical Laminar Flow Cabinet,
Model ACB-4E_*

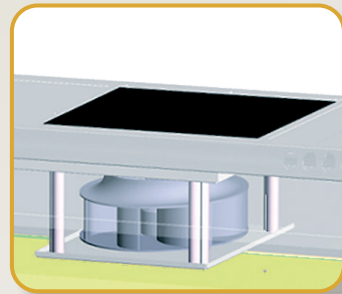

Pre-filter



**Sentinel™ Silver
Microprocessor Controller**



Sliding Sash Window



Stainless Steel Work Tray

OptiMair™ Vertical Laminar Flow Engineering Drawing

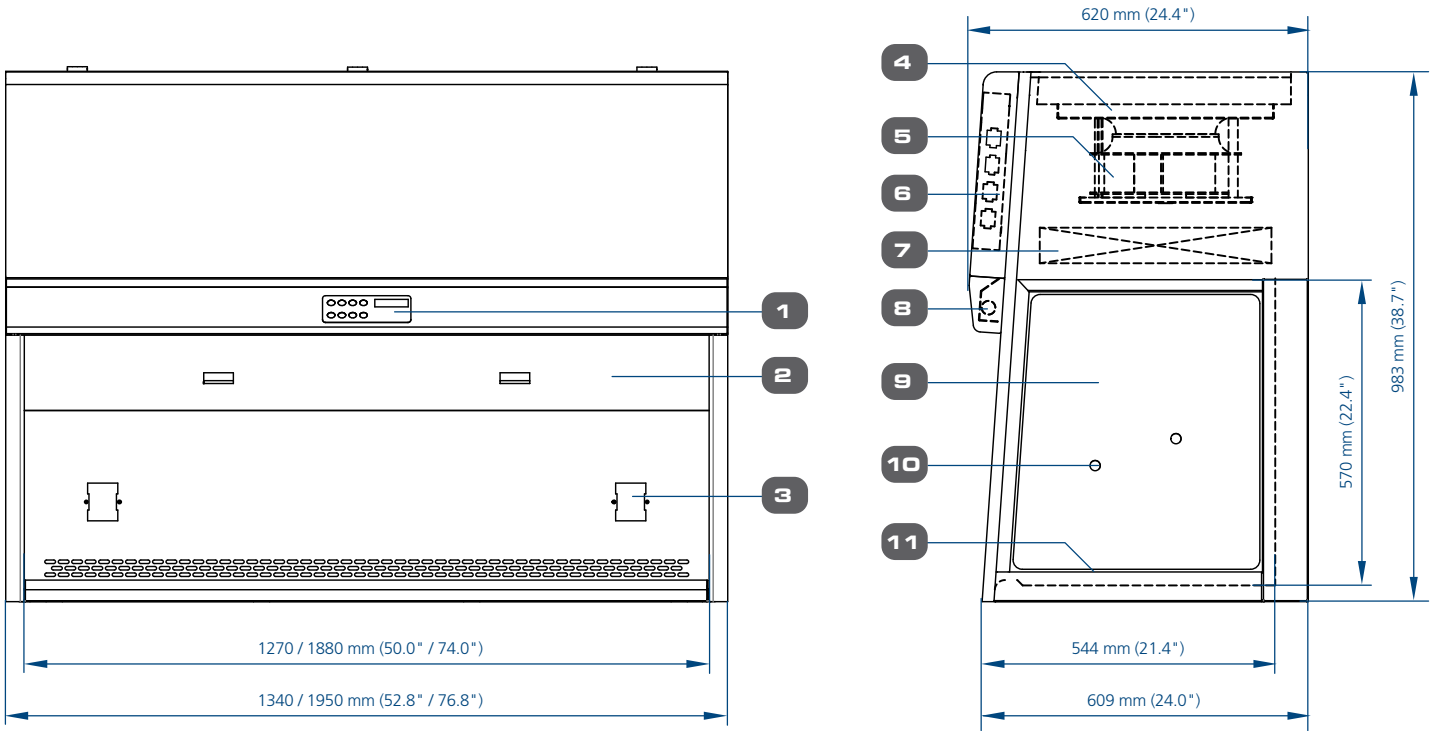

- | | | | |
|---|---------------------|-----------------------------|--|
| 1. Sentinel™ Silver Microprocessor Controller | 4. Pre-filter | 7. ULPA Filter | 10. Service Fixture Retrofit Kit Provision |
| 2. Tempered Glass Sliding Sash Window | 5. AC Blower | 8. LED Lamp | 11. Stainless Steel Work Tray |
| 3. Electrical Outlet | 6. Electrical Panel | 9. Tempered Glass Side Wall | |

OptiMair™ Airflow Diagram

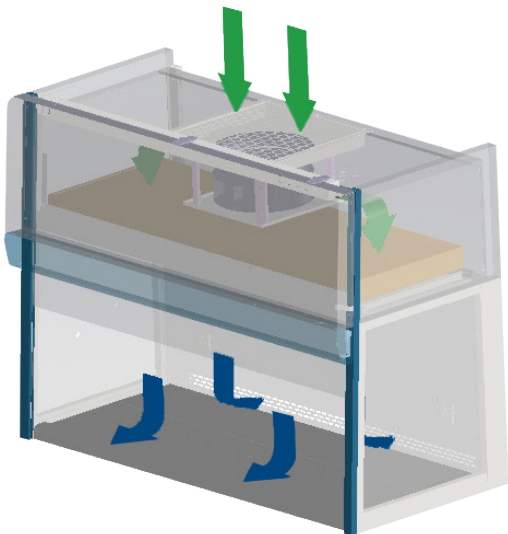

- During operation, room air is drawn in from the top of the cabinet through a washable pre-filter with 20% arrestance, trapping larger particles and prolonging the life of the main filter.
- The air is then forced evenly through the ULPA filter resulting in a unidirectional stream of clean air projected vertically over the internal work zone. All airborne contaminants are flushed and diluted, resulting in a particulate free work environment.
- The purified air then leaves the main work chamber across the entire open front of the cabinet and through Auto-Purge™ slots at the back wall of the work zone to eliminate air turbulence and the possibility of dead-air corners in the work zone.
- A nominal filter face velocity of 0.30 m/s (60 fpm) ensures that there is sufficient number of air changes within the enclosed area of the clean bench in order to maintain cleanliness.

- Room air / Inflow air
- ULPA-filtered air

Applications

Mycology and Microbiology

Plant and Mammalian Cell Culture

Clinical Pharmacy and Hospital Laboratory

Non-hazardous biotechnology procedures

Semiconductor Industry

General Specifications, OptiMair™ Vertical Laminar Flow Cabinet

Model		ACB-4E	ACB-6E
Nominal Size		1.2 meter (4')	1.8 meters (6')
External Dimensions (W x D x H)	Without Base Stand	1340 x 620 x 983 mm (52.8" x 24.4" x 38.7")	1950 x 620 x 983 mm (76.8" x 24.4" x 38.7")
	With Optional Base Stand, 711 mm (28") type	1340 x 620 x 1694 mm (52.8" x 24.4" x 66.7")	1950 x 620 x 1694 mm (76.8" x 24.4" x 66.7")
Internal Work Area, Dimensions (W x D x H)		1270 x 524 x 570 mm (50.0" x 20.6" x 22.4")	1880 x 524 x 570 mm (74.0" x 20.6" x 22.4")
Usable Work Zone		0.67 m ² (7.2 sq.ft.)	0.99 m ² (10.7 sq.ft.)
Initial Airflow Velocity		0.3 m/s (60 fpm)	
Air Volume		566 m ³ /h (333 cfm)	850 m ³ /h (500 cfm)
ULPA Filter Typical Efficiency		99.99% for particles size at 0.3 microns	
Sound Emission Per IEST-RP-CC002.2*		<61 dBA	<63 dBA
LED Lamp Intensity At Zero Ambient		>1000 Lux (74 foot candles)	
Cabinet Construction	Main Body	1.2 mm / 0.05" / 18 gauge electro-galvanized steel with white oven-baked epoxy powder-coated finish	
	Work Zone	1.2 mm (0.05") 18 gauge stainless steel, grade 304, 4B finish	
	Side Walls	Tempered glass	
Electrical Power Rating 1: 220-240 VAC, 50Hz, 1Ø	Cabinet Full Load Amps (FLA)	6.3 A	6.5 A
	Optional Outlets FLA	5 A	
	Cabinet Nominal Power	275 W	285 W
	Cabinet BTU	938	972
Electrical Power Rating 3: 220-240 VAC, 60Hz, 1Ø	Cabinet Full Load Amps (FLA)	1.3 A	1.6 A
	Optional Outlets FLA	5 A	
	Cabinet Nominal Power	198 W	
	Cabinet BTU	676	
Net Weight**		140 kg (308 lbs)	182 kg (400 lbs)
Shipping Weight**		178 kg (392 lbs)	231 kg (508 lbs)
Shipping Dimensions, Maximum (W x D x H)**		1430 x 749.5 x 1233 mm (56.3" x 29.5" x 48.5")	2110 x 749.5 x 1233 mm (83.1" x 29.5" x 48.5")
Shipping Volume, Maximum**		1.32 m ³ (46.6 cu.ft)	1.95 m ³ (68.9 cu.ft)

*Noise reading in open field condition/ anechoic chamber.

**Cabinet only; excludes optional stand.

Accessories for OptiMair™ Vertical Laminar Flow Cabinet

Model	Description
SF-2U	Universal Service Fixture Kit, Suitable for Air/Gas/Vac, Field Installed
SPA-4E0	Support Stand, Adjuster and wheel
IV-XXX-XXX	IV Bar Kit, Includes 6 Hooks, Specify Model When Ordering, Field Installed

Note: 2 Universal (European / American / Japanese / Asia-Pacific) electrical outlets are standard on all OptiMair™ cabinets.

	Cabinet Performance	Air Quality	Filtration	Electrical Safety
Standards Compliance	AS 1386.5, Australia IEST-RP-CC002.2, Worldwide	ISO 14644.1, Class 3, Worldwide IEST-G-CC1001, Worldwide IEST-G-CC1002, Worldwide	EN-1822 (H13), Europe IEST-RP-CC001.3, Worldwide IEST-RP-CC007.1, Worldwide IEST-RP-CC034.1, Worldwide	UL 61010-1, USA CAN/CSA-22.2, No.61010-1 EN 61010-1, Europe IEC 61010-1, Worldwide

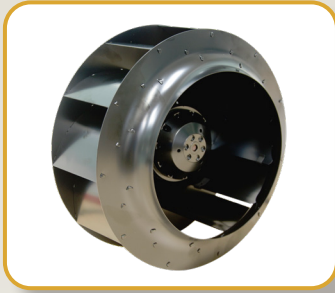

AC Blower

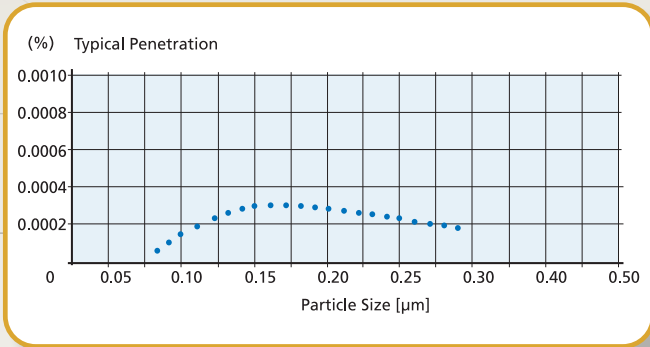

ULPA Filter

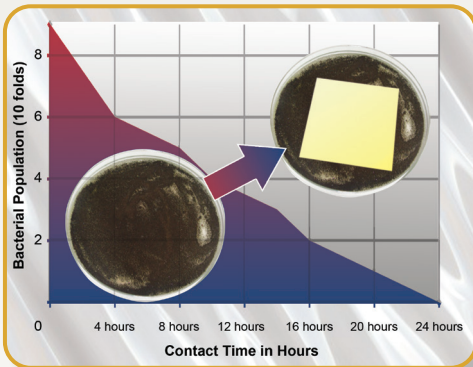

Isocide™ Antimicrobial Coating



Acrylic Fixed Sash



*Enterprise® Laminar Flow Straddle Units,
Model EQU/06-ESUS*

Standards Compliance	Cabinet Performance	ISO 14644-1 IEST-QC IEST-QC
	IENT-RP-CC002.2, Worldwide	



Magnehelic Gauge

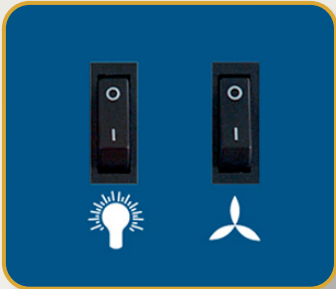

Light and Blower Switch



Acrylic Side Panels



Stainless Steel Table



Caster Wheel and Leveling Feet

Air Quality	Filtration	Electrical Safety
44.1, Class 4, Worldwide G-CC1001, Worldwide G-CC1002, Worldwide	EN-1822 (H14), Europe IEST-RP-CC001.3, Worldwide IEST-RP-CC007.1, Worldwide IEST-RP-CC034.1, Worldwide	UL 61010-1, USA CAN/CSA-22.2, No.61010-1 EN 61010-1, Europe IEC 61010-1, Worldwide

the microbiological testing methods adapted from this biological safety cabinet standard.

Model EQU/0_-ESUS Enterprise Laminar Flow Single Straddle Unit Engineering Drawing

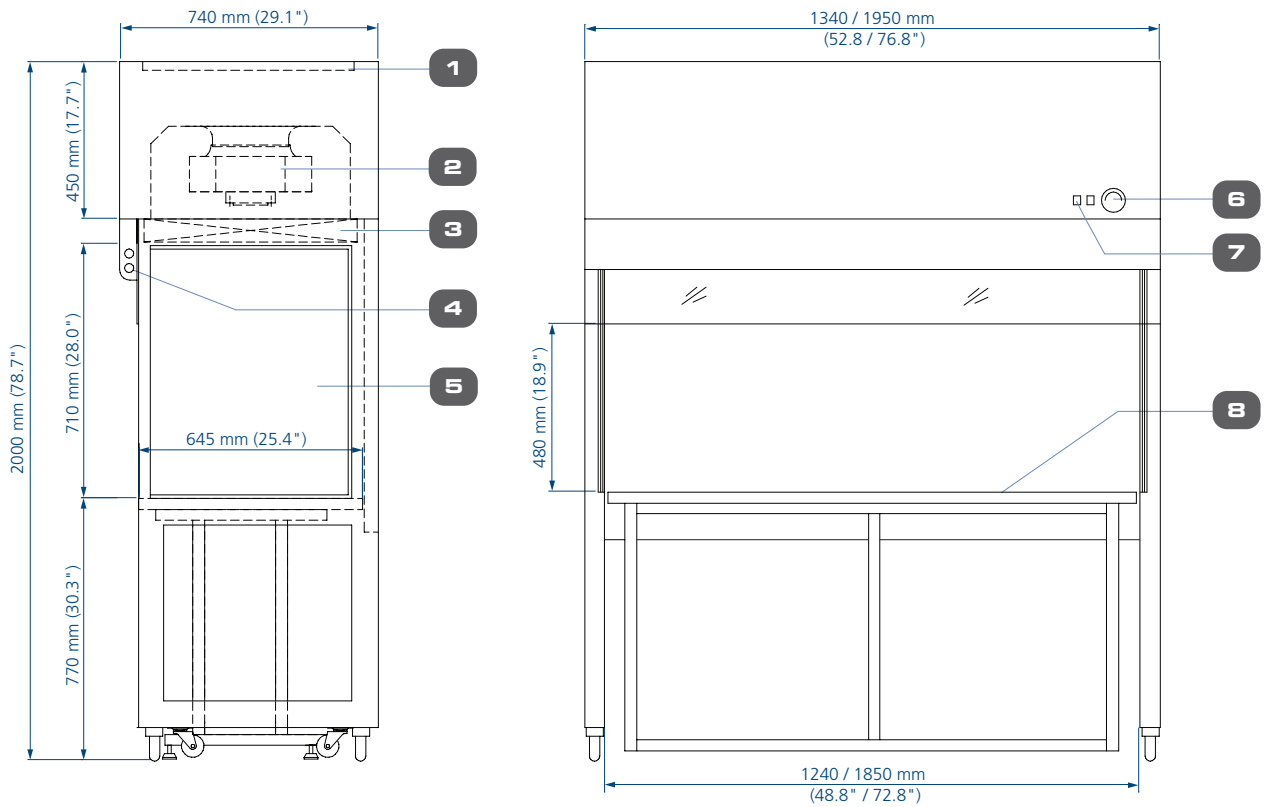

- 1. Pre-filter
- 2. AC Blower
- 3. ULPA Filter

- 4. LED Lamp
- 5. Acrylic Side Walls
- 6. Pressure Gauge

- 7. Operating Switches
- 8. Isolated Stainless Steel Table

General Specifications, Enterprise® Laminar Flow Single Straddle Unit

Model	EQU/04-ESUS 2020324	EQU/06-ESUS 2020326
Nominal Size	1.2 meter (4')	1.8 meter (6')
External Dimensions (W x D x H)	1340 x 740 x 2000 mm (52.7" x 29.1" x 78.7")	1950 x 740 x 2000 mm (76.7" x 29.1" x 78.7")
Internal Work Area, Dimensions (W x D x H)	1240 x 645 x 710 mm (48.8" x 25.4" x 28.0")	1850 x 645 x 710 mm (72.8" x 25.4" x 28.0")
Usable Work Zone	1230 x 645 mm (48.4" x 25.4")	1840 x 645 mm (72.4" x 25.4")
Initial Airflow Velocity	Average of 0.45 m/s or 90 fpm (+/- 20%)	
Air Volume	1205 m³/h	1810 m³/h
Pre-Filter	Washable non-woven polyester fibers with 90% arrestance and 20% efficiency	
HEPA Filter Typical Efficiency	99.99% at partial size 0.3 µm	
Sound Emission Per IEST-RP-CC002.2	65 dBA	67 dBA
LED Lamp Intensity At Zero Ambient	1000 Lux (92.9 foot-candles)	
Cabinet Construction	Main Body	1.5 mm (0.06") electro-galvanised steel with white oven-baked Isocide™ epoxy powder-coated finish.
	Work Zone	1.2mm (0.05") 18 gauge stainless steel grade 304
Net Weight	300 kg (661 lbs)	400 kg (881 lbs)
Shipping Weight	350 kg (772 lbs)	450 kg (992 lbs)
Shipping Dimensions, Maximum (W x D x H)	1950 x 950 x 1380 mm 76.8" x 37.4" x 54.3"	2050 x 950 x 1500 mm 80.7" x 37.4" x 59.1"
Electrical 220-240 VAC, 50 Hz, 1ø	Cabinet Full Load Amps (FLA)	1.8 A
	Cabinet Nominal Power	378 W
	Cabinet BTU	1290
		4 A
		628 W
		2143

Model EQU/0_-ESUD Enterprise Laminar Flow Double Straddle Unit Engineering Drawing

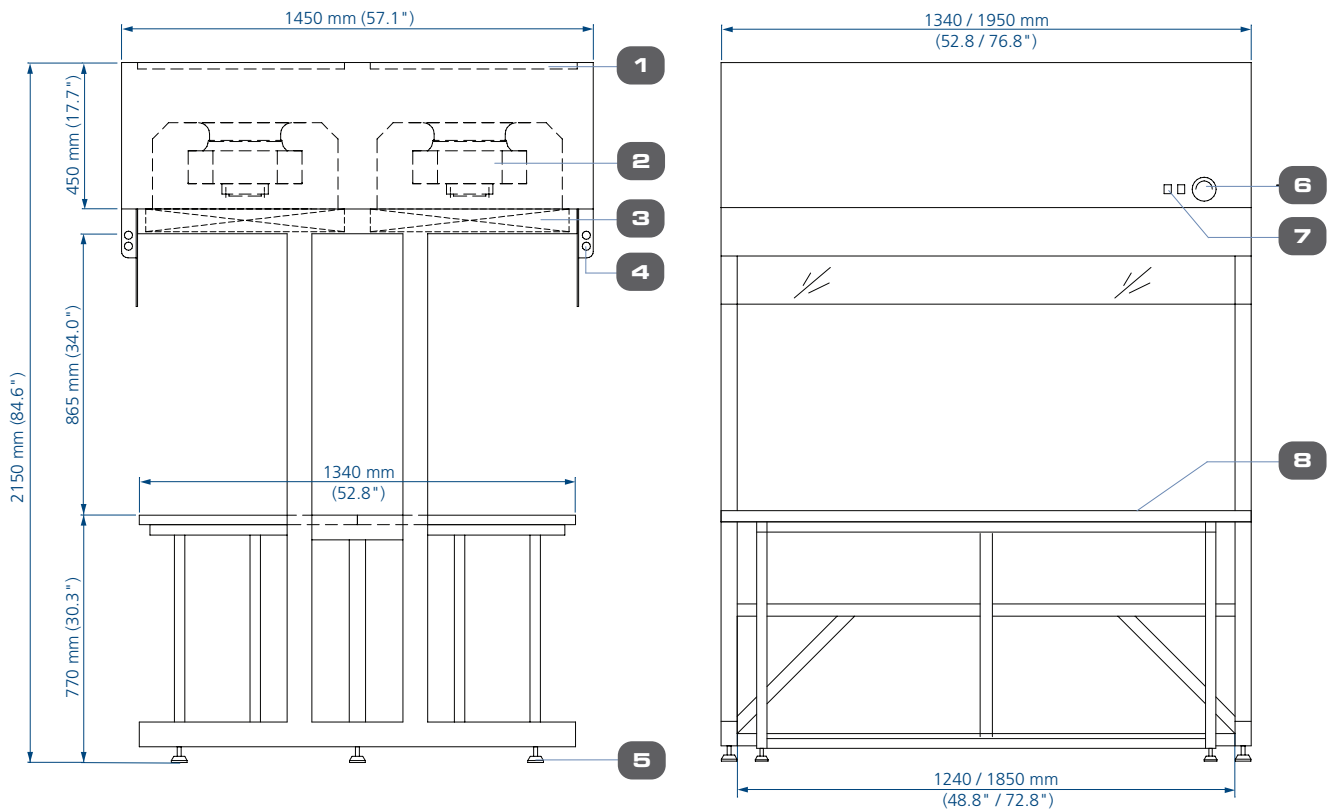

- 1. Pre-filter
- 2. AC Blower
- 3. ULPA Filter

- 4. LED Lamp
- 5. Leveling Feet
- 6. Pressure Gauge

- 7. Operating Switches
- 8. Isolated Stainless Steel Table

General Specifications, Enterprise® Laminar Flow Double Straddle Unit

Model	EQU/04-ESUD 2020320	EQU/06-ESUD 2020322	
Nominal Size	1.2 meter (4')	1.8 meter (6')	
External Dimensions (W x D x H)	1340 x 1450 x 2150 mm (52.7" x 57.1" x 84.6")	1950 x 1450 x 2150 mm (76.7" x 57.1" x 84.6")	
Internal Work Area, Dimensions (W x D x H)	1240 x 1340 x 865 mm (48.8" x 52.8" x 34")	1850 x 1340 x 865 mm (72.8" x 52.8" x 34")	
Usable Work Zone	1240 x 1340 (48.8" x 52.8")	1850 x 1340 (72.8" x 52.8")	
Initial Airflow Velocity	Average of 0.45 m/s or 90 fpm (+/- 20%)		
Air Volume	2410 m³/h	3610 m³/h	
Pre-Filter	Washable non-woven polyester fibers with 90% arrestance and 20% efficiency		
HEPA Filter Typical Efficiency	99.99% at partial size 0.3 µm		
Sound Emission Per IEST-RP-CC002.2	65 dBA	67 dBA	
LED Lamp Intensity At Zero Ambient	1000 Lux (92.9 foot-candles)		
Cabinet Construction	Main Body	1.5 mm (0.06") electro-galvanised steel with white oven-baked Isocide™ epoxy powder-coated finish.	
	Work Zone	1.2mm (0.05") 18 gauge stainless steel grade 304	
Net Weight	600 kg (1323 lbs)	800 kg (1764 lbs)	
Shipping Weight	650 kg (1433 lbs)	850 kg (1874 lbs)	
Shipping Dimensions, Maximum (W x D x H)	1500 x 900 x 2200 mm (59.0" x 35.4" x 86.6")	2100 x 900 x 2200 mm (82.7" x 35.4" x 86.6")	
Electrical 220-240 VAC, 50 Hz, 1ø	Cabinet Full Load Amps (FLA)	3.6 A	8 A
	Cabinet Nominal Power	756 W	1256 W
	Cabinet BTU	2580	4286

EQU/0_-ESUS Enterprise Laminar Flow Straddle Unit Airflow Diagram

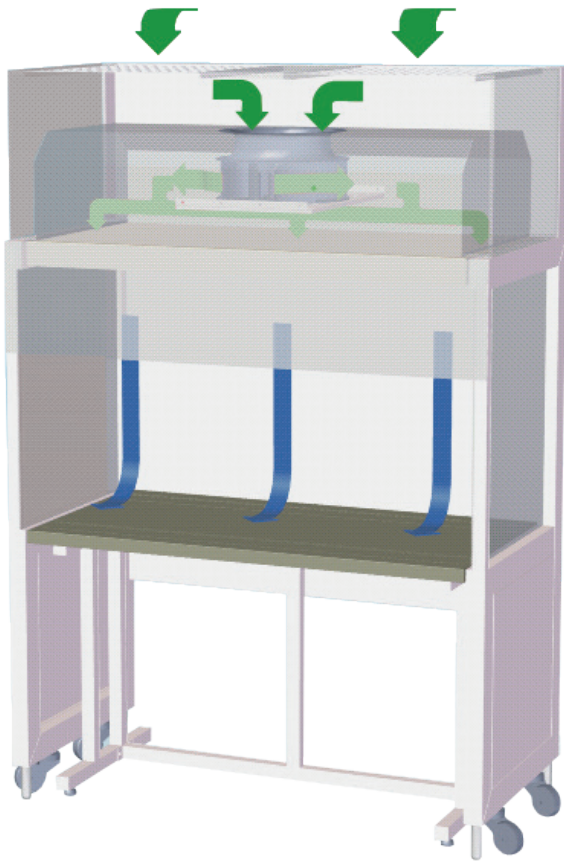

- During operation, room air is drawn through the top of the straddle unit via a washable polyurethane pre-filter with 20% arrestance, trapping larger particles and increasing the life of the main filter.
- The air is then forced evenly through the ULPA filter with >99.999% efficiency, resulting in a unidirectional stream of clean air projected vertically over the internal work zone. All airborne contaminants are flushed and diluted, resulting in a particulate-free work environment.
- The purified air then leaves the storage area across the entire open front of the straddle unit.
- A nominal filter face velocity of 0.45 m/s (90 fpm) ensures that there is a sufficient number of air changes within the enclosed area of the straddle unit in order to maintain cleanliness.

- Room air / Inflow air
- ULPA-filtered air

Esco Centrifugal Fan with External Rotor Motor vs. Conventional Fan with Standard Motor

- Esco cabinets use German made ebm-papst® permanently lubricated, centrifugal motor/blowers with external rotor designs.
- Integrated blades narrow the profile and eliminate need for a motor shaft.
- Motors are selected for energy efficiency, compact design, and flat profile. The completely integrated assembly optimizes motor cooling.
- All rotating parts are unitized and balanced for smooth, quiet, vibration-free operation.

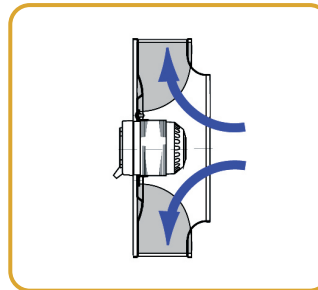

*Esco Centrifugal Fan
with External Rotor Motor*

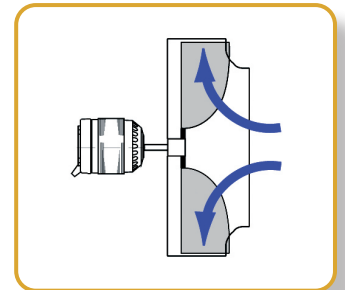

Conventional Fan with Standard Motor

Applications

Cleanrooms, Electronics Assembly, Semiconductors, Aerospace, Pharmaceutical, Medical Devices Industries

Mycology and Food Microbiology

Plant and Mammalian Cell Culture

Clinical Pharmacy and Hospital Use

Applications benefiting from the isolated work surface frame design which virtually eliminates vibration

providing

reliable product protection

and

energy-efficient technology



Green Product



Airstream® Gen 3
Horizontal Laminar Flow Cabinet,
Model LHG-4AG-F_



Airstream® Gen 3
Vertical Laminar Flow Cabinet,
Model LVS-4AG-F_



OptiMair™
Vertical Laminar Flow Cabinet,
Model ACB-4E_



Enterprise® Laminar Flow Straddle Units,
Model EQUI06-ESUS

IT'S WHAT ESCO LAMINAR FLOW CABINETS DO.

#Escogoesgreen

ESCO LIFESCIENCES GROUP

42 LOCATIONS IN 21 COUNTRIES ALL OVER THE WORLD



-  Global Offices
-  Licensee
-  Distributors
-  Factories
-  R&D Centers
-  Regional Distribution Centers

Follow us on social media, download our apps,
and scan the QR code for more info.



@Escolifesciences



@Escolifesciences



@Escolifesci



@Esco



@Escolifesciences



@Escolifesciences



Esco Lifesciences



Esco Lifesciences

ESCO

LIFESCIENCES GROUP

Esco Micro Pte. Ltd. • 21 Changi South Street 1 • Singapore 486 777
Tel +65 6542 0833 • mail@escolifesciences.com
www.escolifesciences.com

Esco Technologies, Inc. • 903 Sheehy Drive, Suite F, Horsham, PA 19044, USA
Tel: +1 215-441-9661 • Fax 484-698-7757
eti.admin@escolifesciences.com

Esco Lifesciences Group Offices: Bangladesh | China | Denmark | Germany | Hong Kong | India | Indonesia | Italy | Japan | Lithuania
| Malaysia | Myanmar | Philippines | Russia | Singapore | South Africa | South Korea | Taiwan | Thailand | UAE | UK | USA | Vietnam